

Global Infrastructure Index 2019

Public satisfaction and priorities

Global

G8

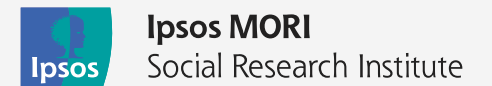

Introduction

- These are the findings of the fourth **Global Infrastructure Index** conducted via Ipsos' Global @dvisor between **26 July – 9 August 2019** in **28 countries** around the world via the Ipsos Online Panel system and involving **19,516** participants:

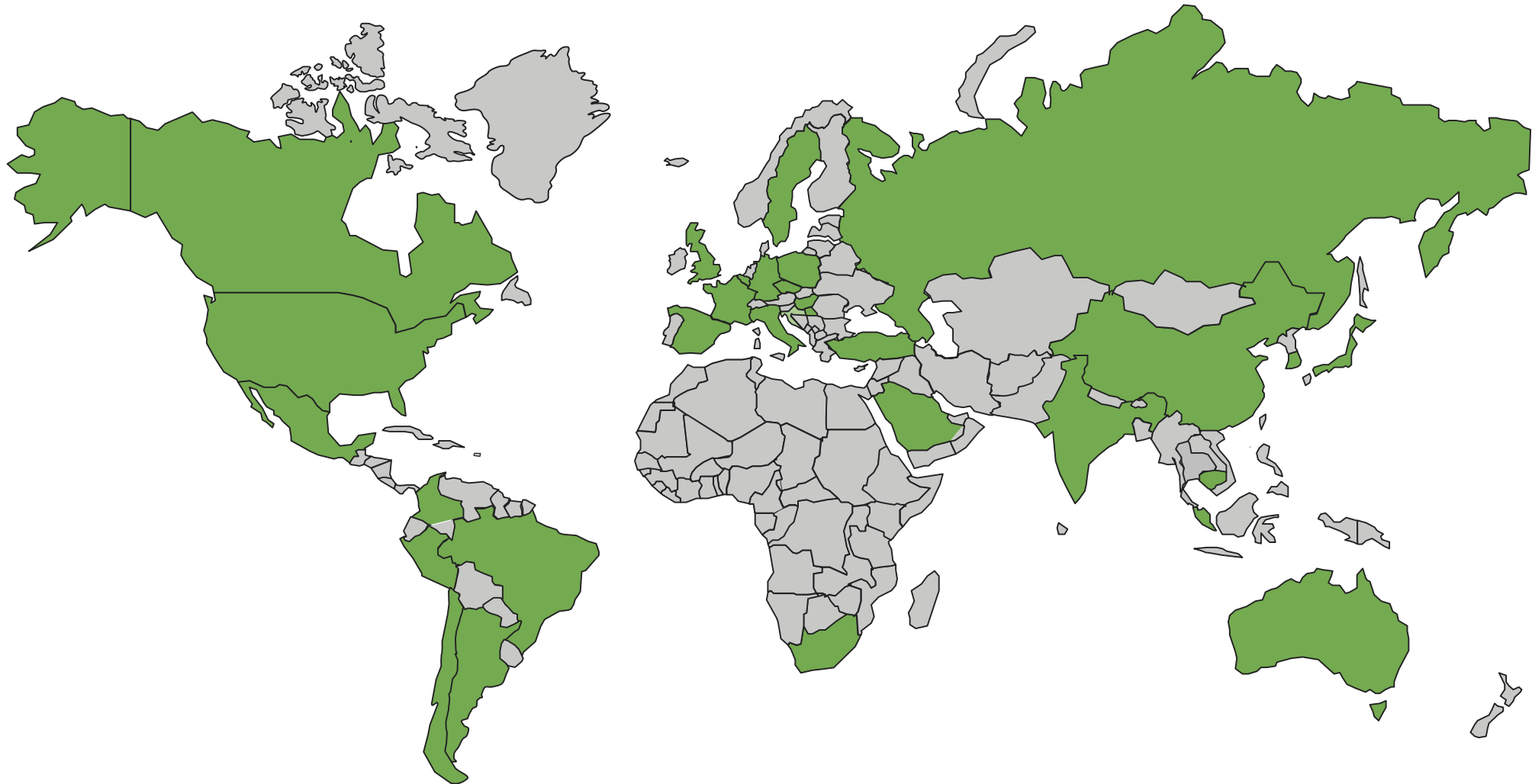

Methodology

- 28 countries, **19,516** participants, **26 July–9 August 2019** (online):
Argentina, Australia*, Belgium, Brazil, Canada*, Chile, China*, Colombia, France*, Germany*, Great Britain*, Hungary, India*, Italy*, Japan*, Malaysia, Mexico, Peru, Poland, Russia, Saudi Arabia, South Africa, South Korea, Serbia, Spain*, Sweden, Turkey and the United States of America*
** denotes 1,000+ sample size*
- Participants were adults aged 18-64 in the US and Canada, and adults aged 16-64 in all other countries.
- Results may not sum to 100% and combinations to their constituent %s (e.g. very/fairly satisfied) due to computer rounding.
- The 2016-2019 surveys used the same methodology, but the profile of participating countries changed. This means that the **global trend** does not always involve a like-for-like comparison. In 2018, Romania and Czech Republic were included, China wasn't. This year, Romania and Czech Republic were not included, but some questions were fielded in China.
- A selection of trends is included. Further information is available:

<https://www.ipsos.com/en/global-infrastructure-index-public-satisfaction-and-priorities-2018> (2018)

<https://www.ipsos.com/ipsos-mori/en-uk/rail-joins-housing-top-infrastructure-priorities-britons> (2017)

<https://www.ipsos.com/ipsos-mori/en-uk/do-more-poll-shows-britons-behind-action-infrastructure> (2016)

Regions

& sample sizes

Europe*

7,502

Belgium
France
Germany
Great Britain
Hungary
Italy
Poland
Serbia
Spain
Sweden

N. America

2,002

Canada
U.S.A.

LATAM

3,503

Argentina
Brazil
Chile
Colombia
Mexico
Peru

APAC

4,508

Australia
India
Japan
Malaysia
South Korea

G8

7,505

Canada
France
Germany
Great Britain
Italy
Japan
Russia
U.S.A.

BRIC

3,008

Brazil
India
Russia

ME Africa

1,501

Saudi Arabia
South Africa
Turkey



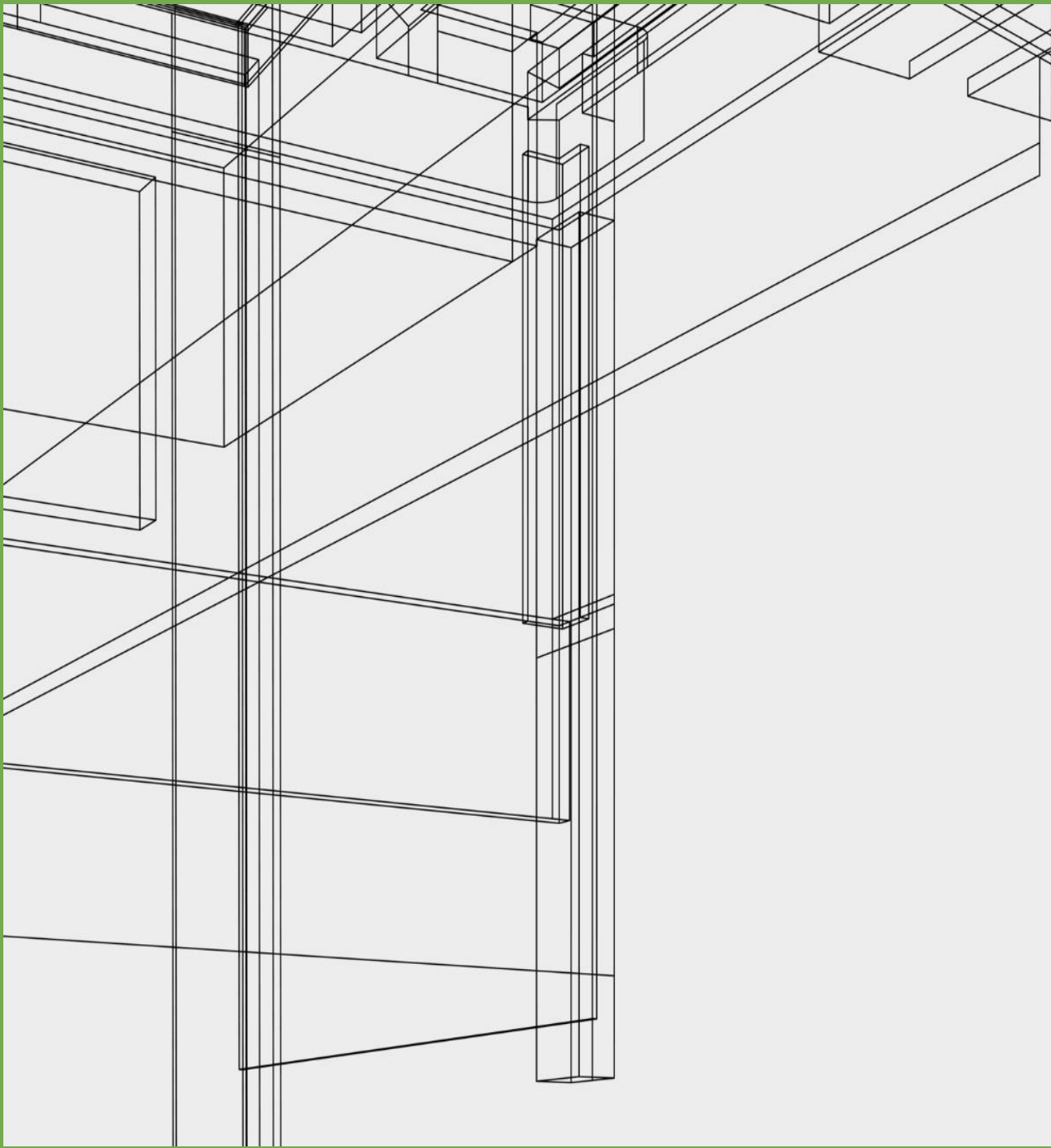

Overall

ratings

Global and Regions: Overall ratings

Q. We now want you to think about [COUNTRY'S] infrastructure.

By infrastructure we mean things we rely on like road, rail and air networks, utilities such as energy and water, and broadband and other communications.

Overall, how satisfied or dissatisfied are you with [COUNTRY'S] national infrastructure?

■ % Very/fairly satisfied

■ % Very/fairly dissatisfied

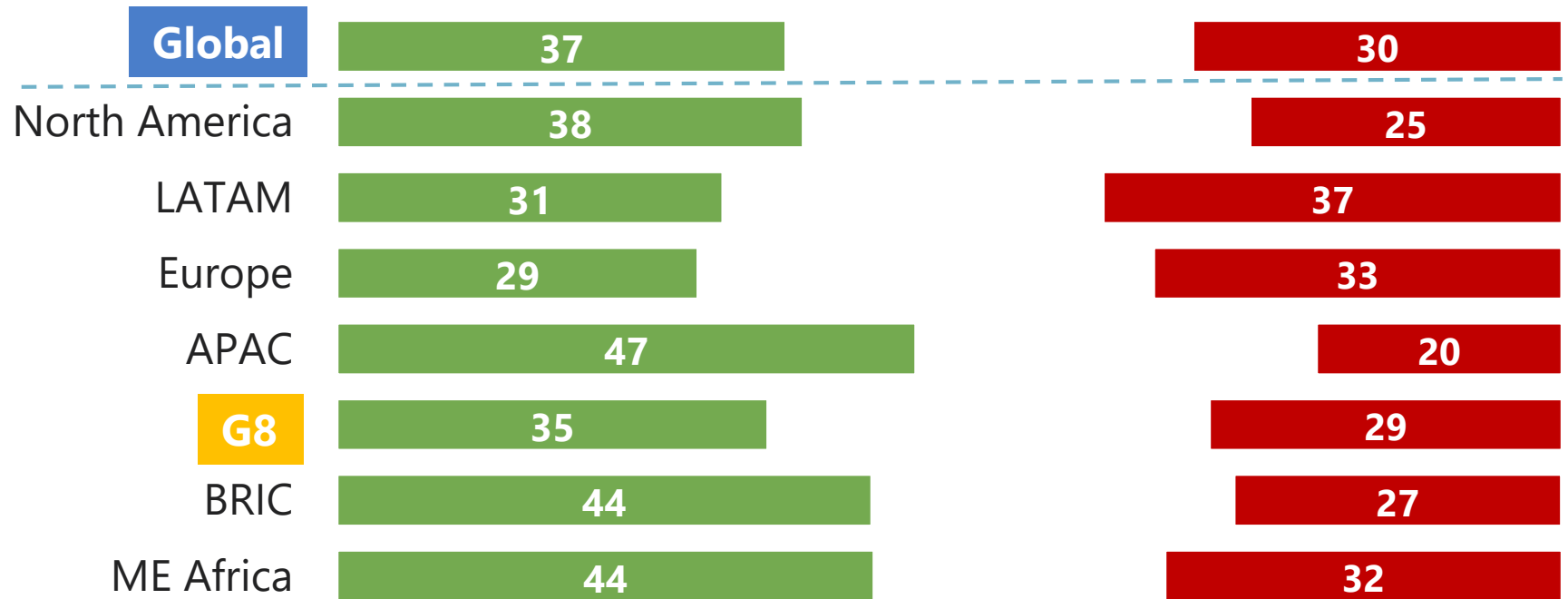

% very/fairly satisfied

Source: Ipsos/ GIIA

Base: 19,516 adults (online), July-August 2019

Trends: Overall ratings

N.B. the 2016-19 surveys used the same methodology, but the profile of participating countries changed between years. This means that the **global and regional trends** do not always involve a strict like-for-like comparison.

Q. We now want you to think about [COUNTRY'S] infrastructure.

By infrastructure we mean things we rely on like road, rail and air networks, utilities such as energy and water, and broadband and other communications.

Overall, how satisfied or dissatisfied are you with [COUNTRY'S] national infrastructure?

% very/fairly satisfied

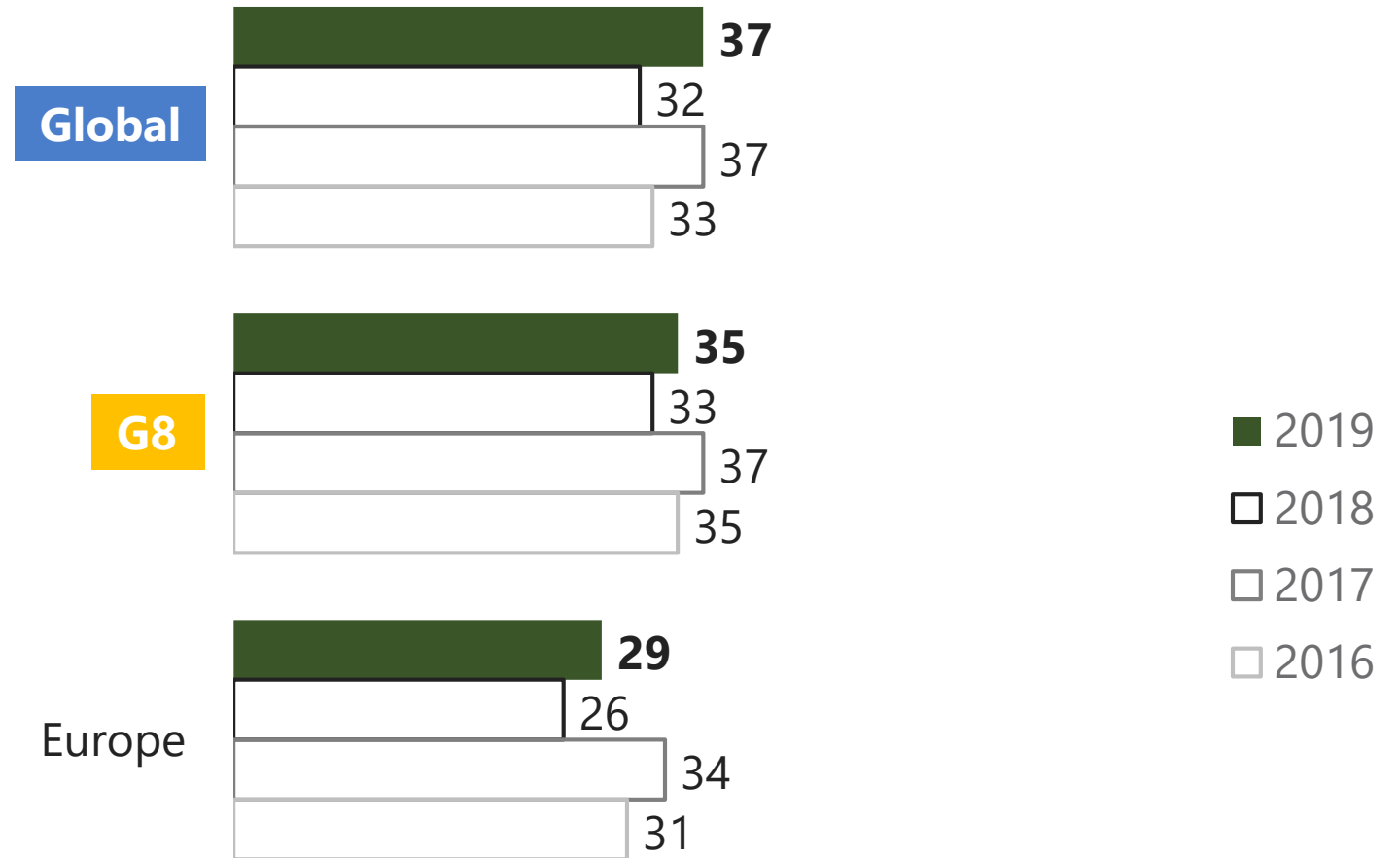

Source: Ipsos/ GIIA

Base: 19,516 adults (online), July-August 2019



Global: Overall

Q. We now want you to think about [COUNTRY'S] infrastructure.

By infrastructure we mean things we rely on like road, rail and air networks, utilities such as energy and water, and broadband and other communications.

Overall, how satisfied or dissatisfied are you with [COUNTRY'S] national infrastructure?

% very/fairly satisfied

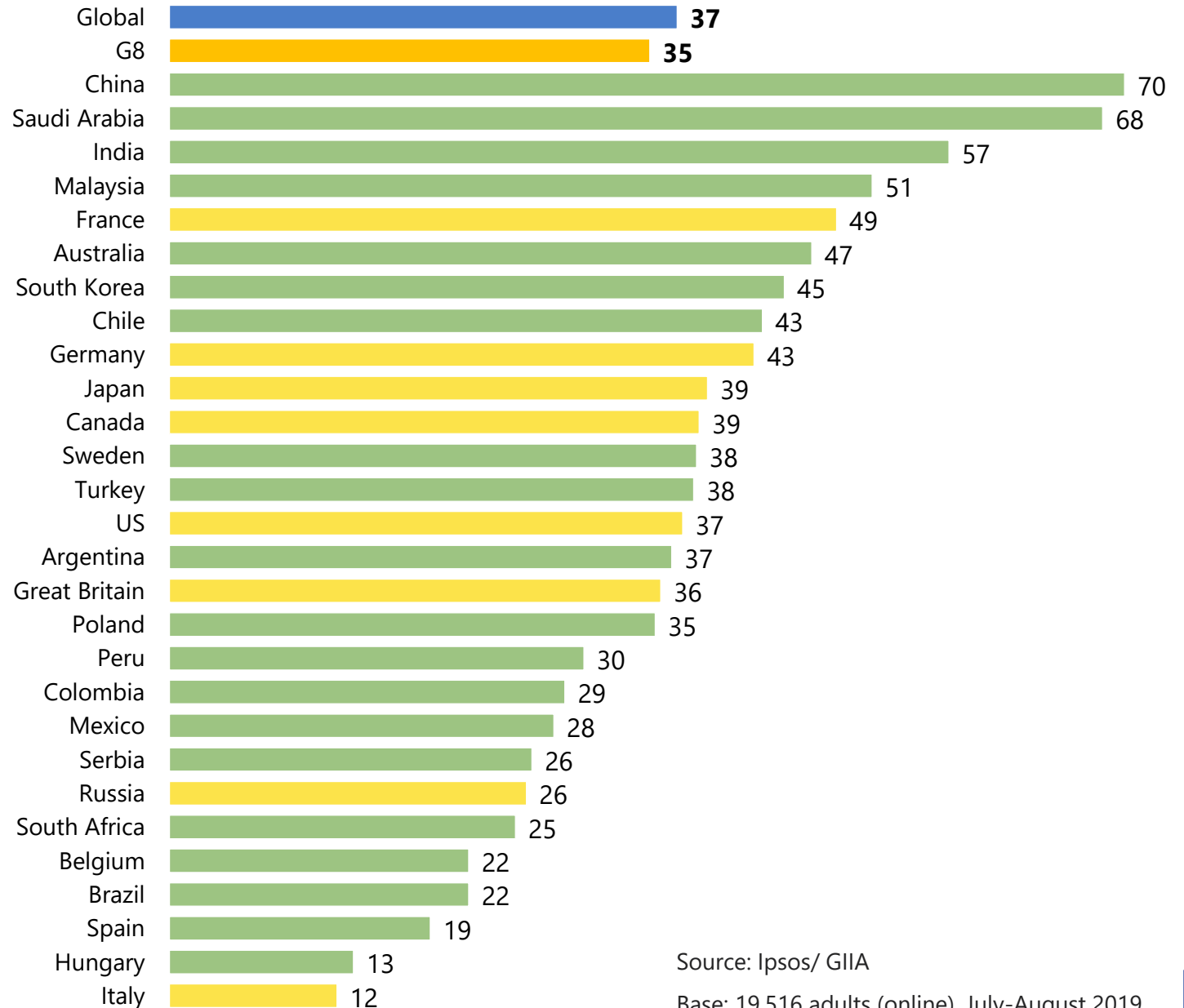

Source: Ipsos/ GIIA

Base: 19,516 adults (online), July-August 2019



Global: Overall

Q. We now want you to think about [COUNTRY'S] infrastructure.

By infrastructure we mean things we rely on like road, rail and air networks, utilities such as energy and water, and broadband and other communications.

Overall, how satisfied or dissatisfied are you with [COUNTRY'S] national infrastructure?

% very/fairly dissatisfied

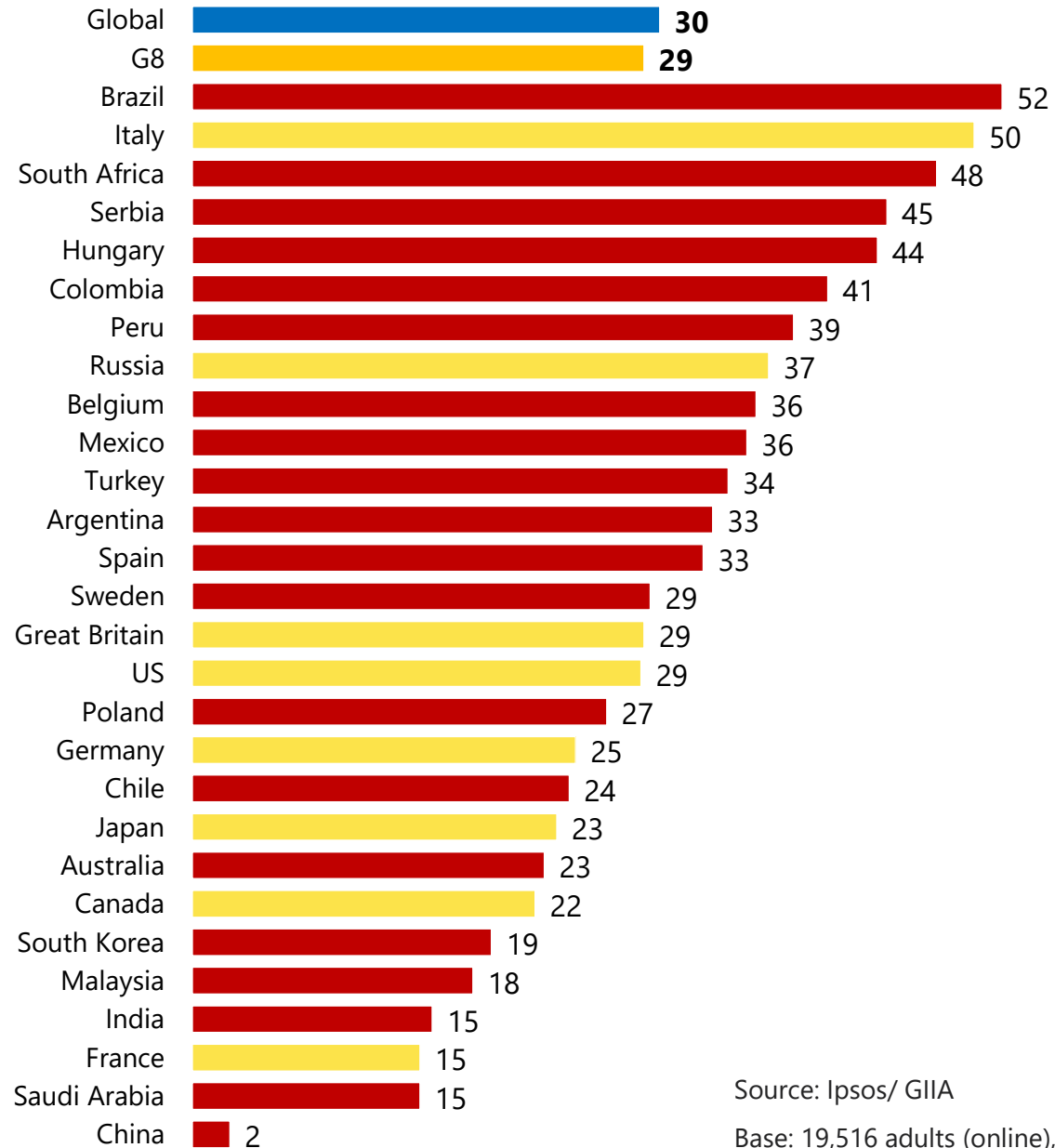

Source: Ipsos/ GIIA

Base: 19,516 adults (online), July-August 2019

Trends: Overall

Q. We now want you to think about [COUNTRY'S] infrastructure.

By infrastructure we mean things we rely on like road, rail and air networks, utilities such as energy and water, and broadband and other communications.

Overall, how satisfied or dissatisfied are you with [COUNTRY'S] national infrastructure?

% very/fairly dissatisfied

N.B. the 2016-19 surveys used the same methodology, but the profile of participating countries changed between years. This means that the **global and regional trends** do not always involve a strict like-for-like comparison.

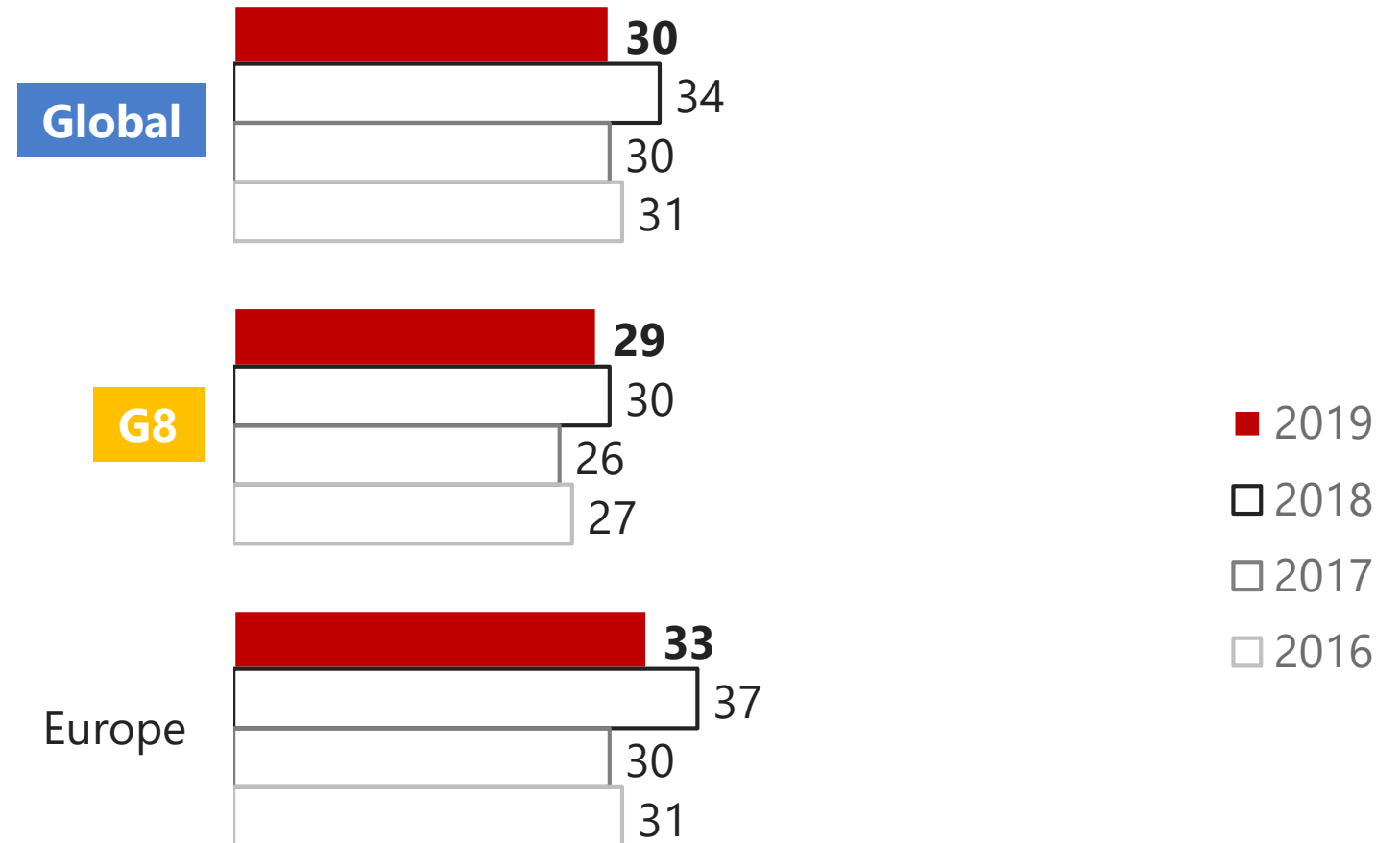

Source: Ipsos/ GIAA

Base: 19,516 adults (online), July-August 2019



G8: Overall ratings v GCI

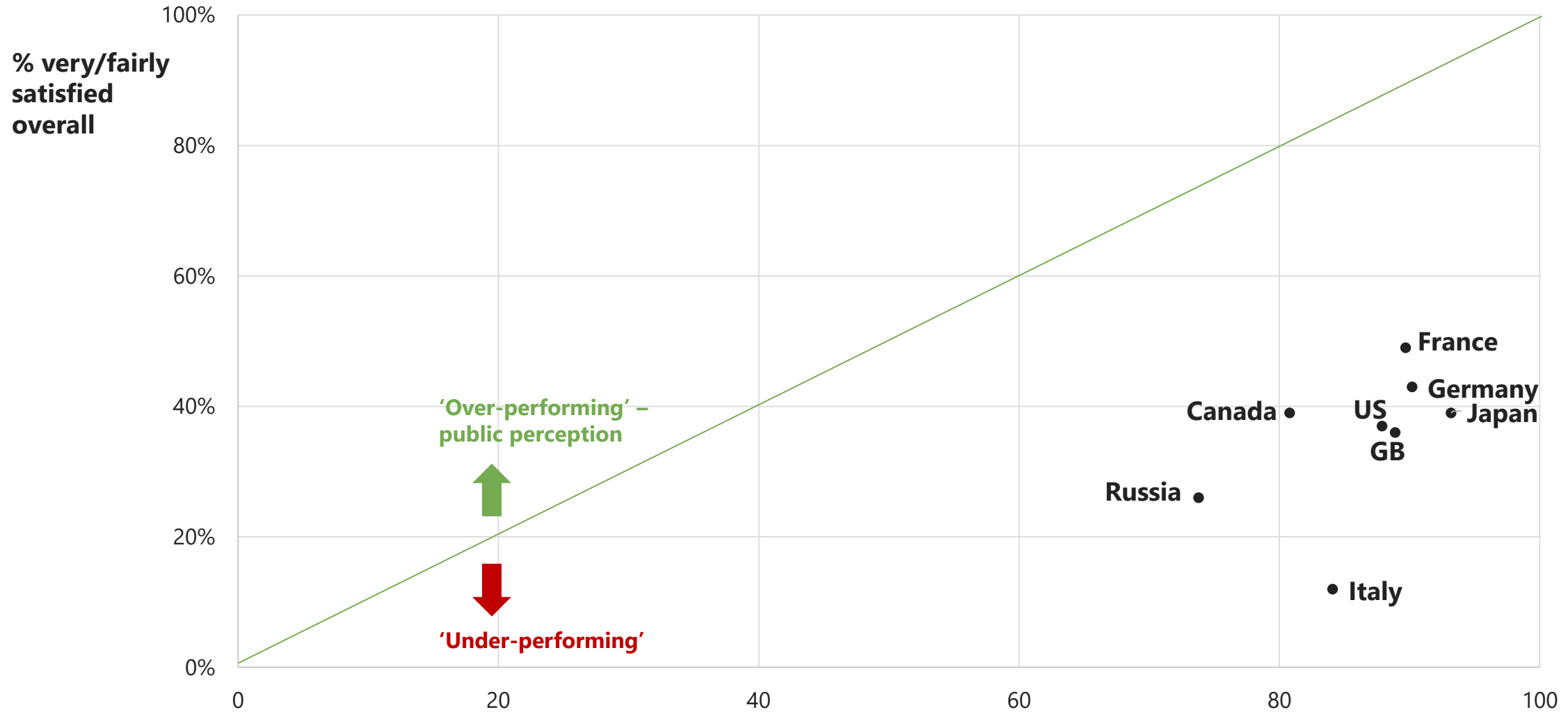

* Source: The World Economic Forum's Global Competitiveness Report 2019

**GCI - Global Competitiveness Index
(2nd pillar – infrastructure, 0-100)***

Source: Ipsos/ GIAA Base: 19,516 adults (online), July-August 2019



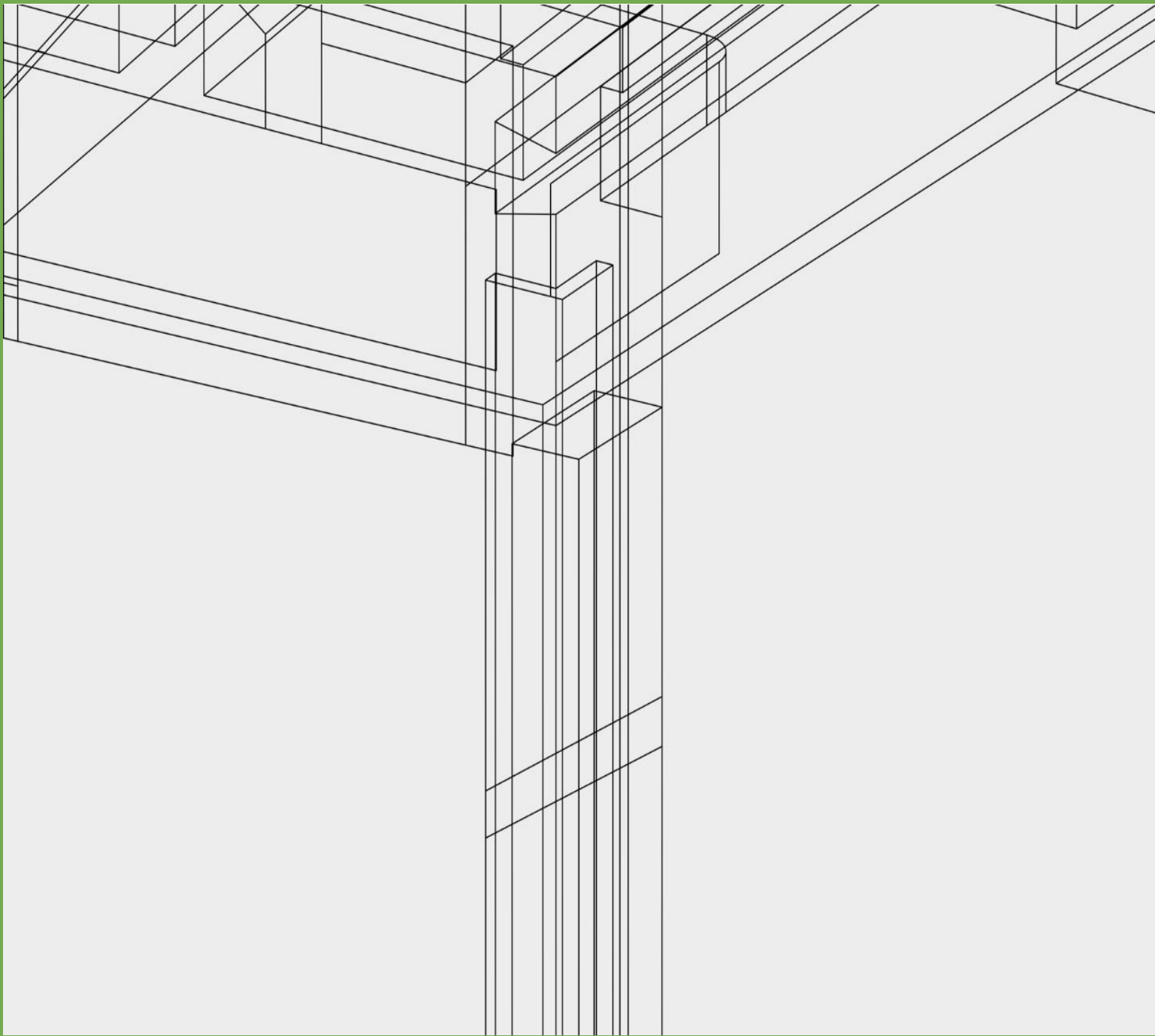

Sectors –

ratings

Global: Sectors

Q. These next questions are about different types of infrastructure.

Please indicate how good or poor you rate the current quality of each one in [COUNTRY]...

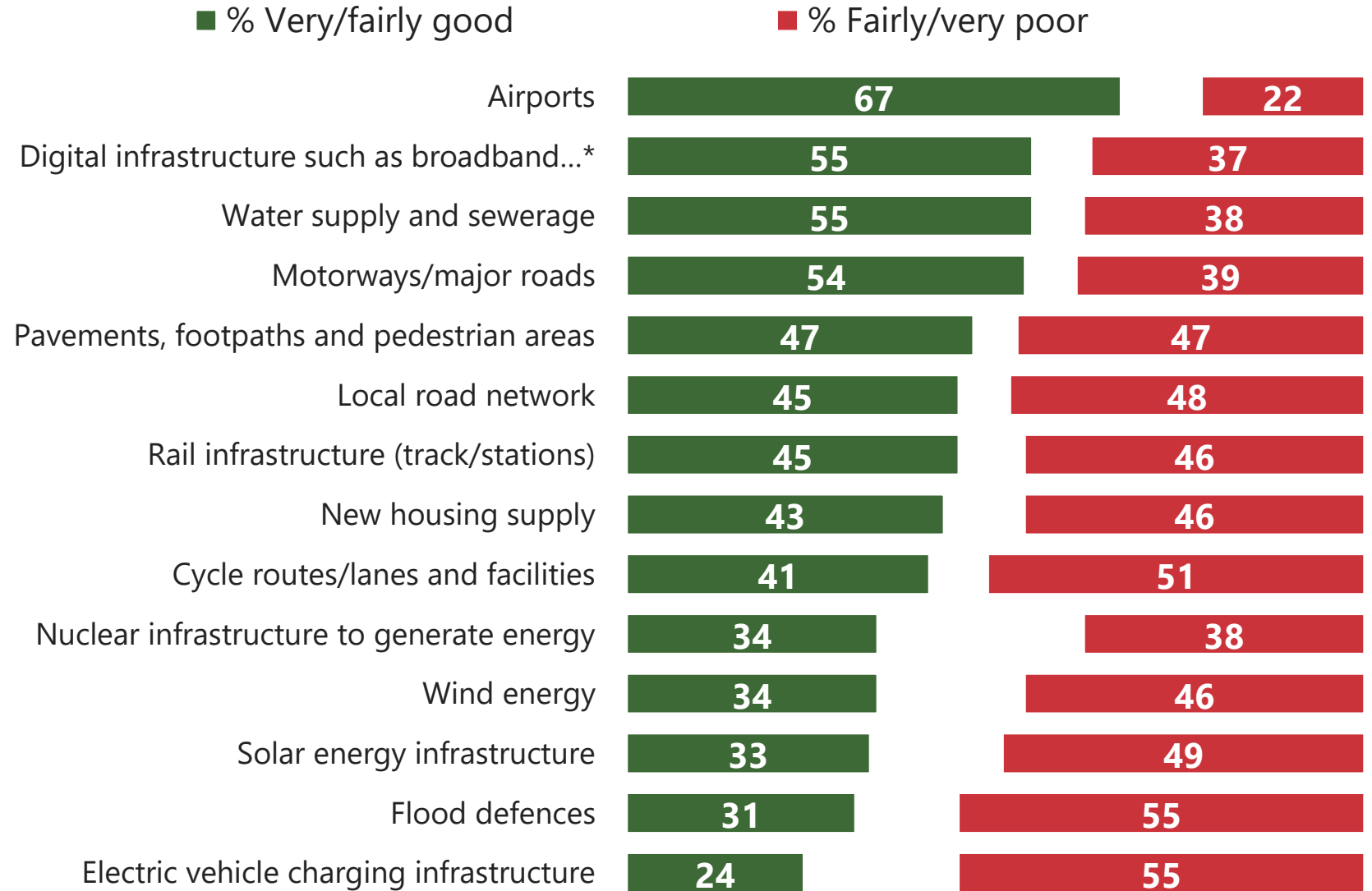

* Asked as 'Digital infrastructure such as high speed broadband' in 2016 and 2017 and 'Digital infrastructure such as high speed broadband, full fibre networks (FTTP), 5G' in 2018

Ranked by % very/fairly good

G8: Sectors

Q. These next questions are about different types of infrastructure.

Please indicate how good or poor you rate the current quality of each one in [COUNTRY]...

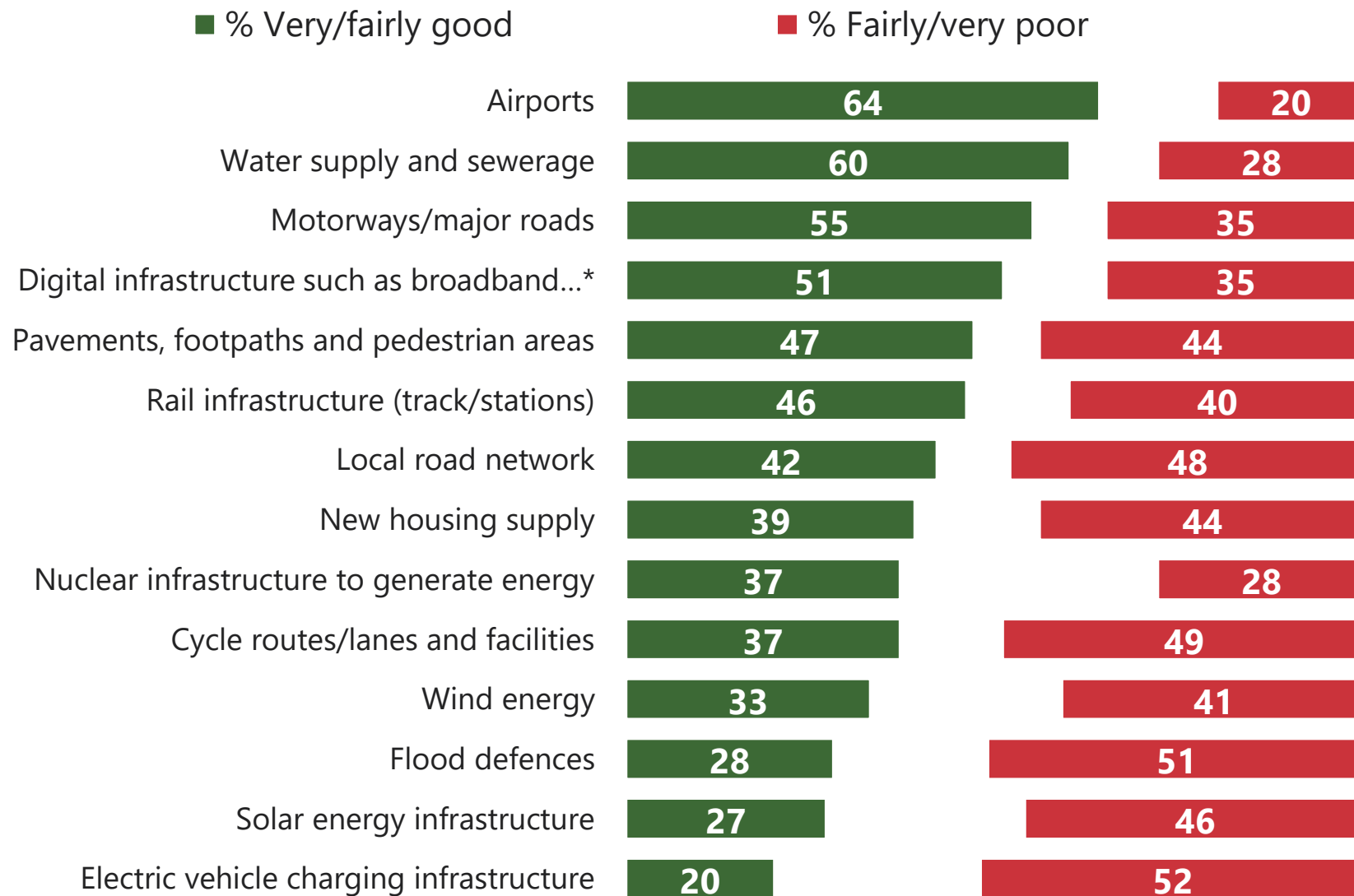

* Asked as 'Digital infrastructure such as high speed broadband' in 2016 and 2017 and 'Digital infrastructure such as high speed broadband, full fibre networks (FTTP), 5G' in 2018

Ranked by % very/fairly good

G8: Sector ratings – trends

Q. These next questions are about different types of infrastructure.

Please indicate how good or poor you rate the current quality of each one in [COUNTRY]...

% very/fairly good

N.B. asked for first time in 2019: pavements, footpaths and pedestrian areas; wind energy; solar infrastructure; cycle routes/lanes and facilities; electric vehicle charging.

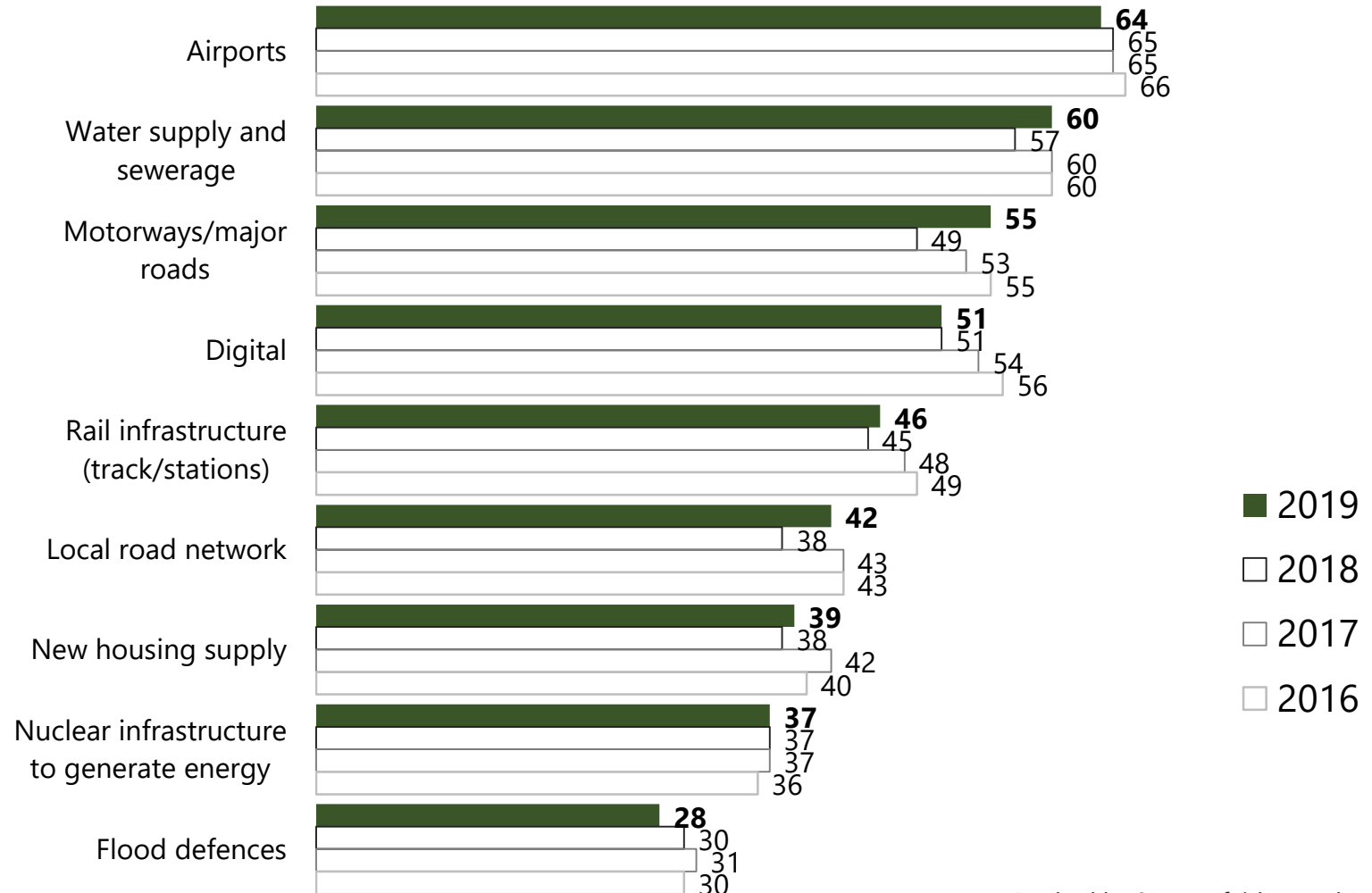

Ranked by % very/fairly good (global, 2019)

Source: Ipsos/ GIIA

Base: 19,516 adults (online), July-August 2019



G8: Sector ratings – trends

N.B. asked for first time in 2019: pavements, footpaths and pedestrian areas; wind energy; solar infrastructure; cycle routes/lanes and facilities; electric vehicle charging.

Nuclear not asked in Australia, Chile, Italy, Malaysia, Peru, Poland, Saudi Arabia, Turkey

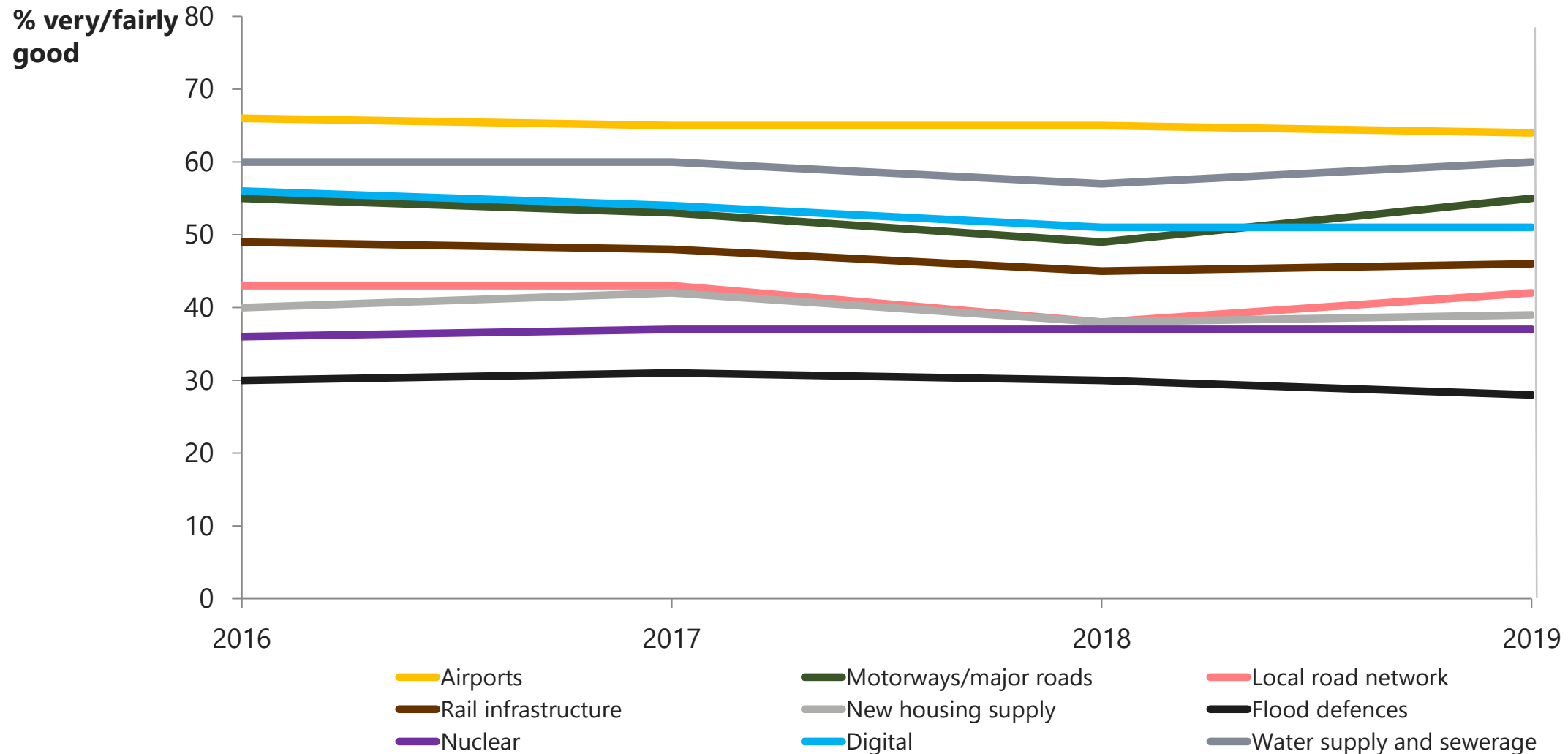

Source: Ipsos/ GIIA Base: 19,516 adults (online), July-August 2019



G8: Overall ratings v average sector ratings

% very/fairly good - sector average

N.B. ratings confined to 8 sectors included in 2018-19 and excluding nuclear (not asked in Italy, 2019)

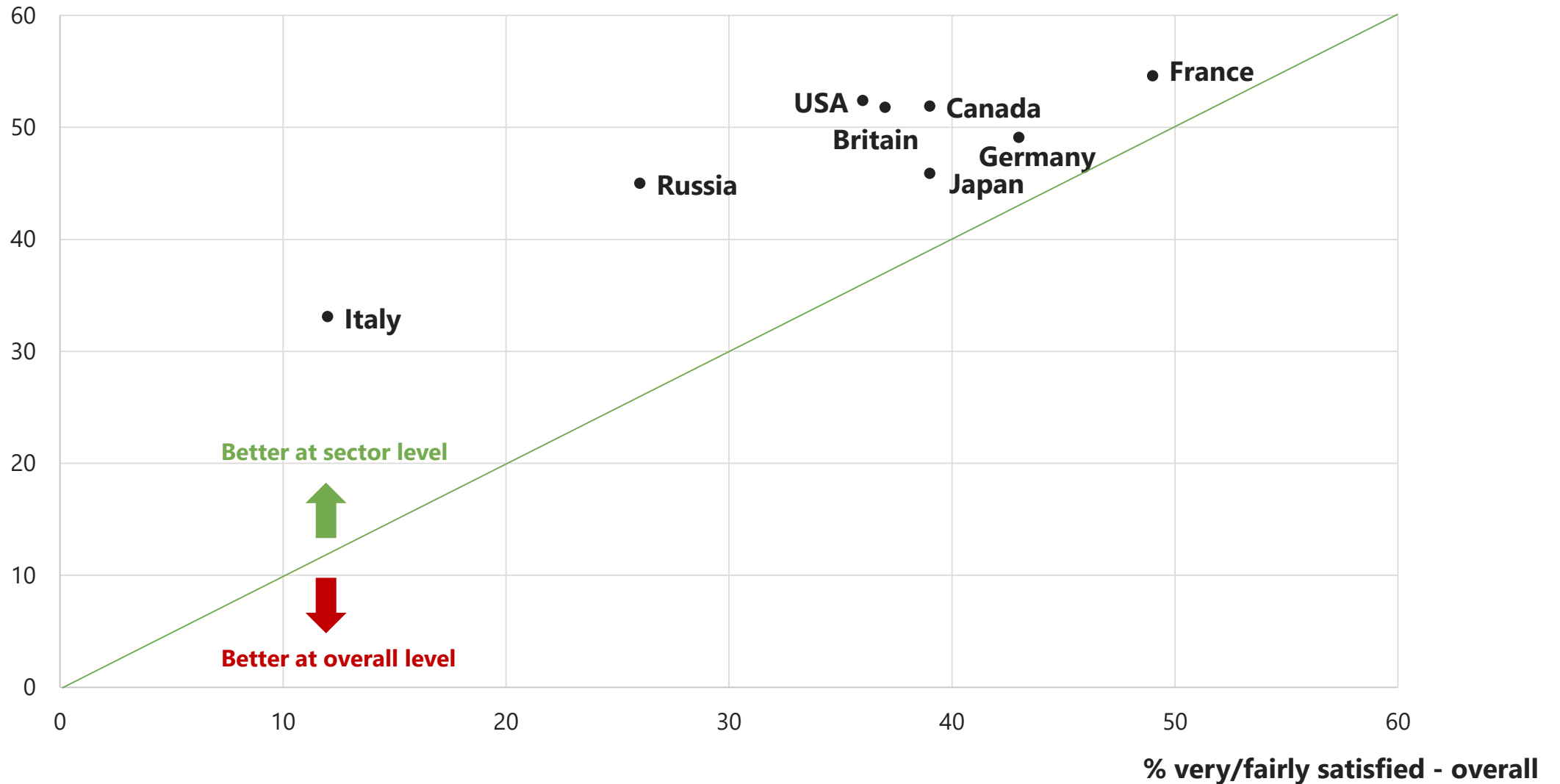

Source: Ipsos/ GIIA Base: 19,516 adults (online), July-August 2019

Airports

Q. These next questions are about different types of infrastructure. Please indicate how good or poor you rate the current quality of each one in [COUNTRY]...

Airports

% very/fairly good

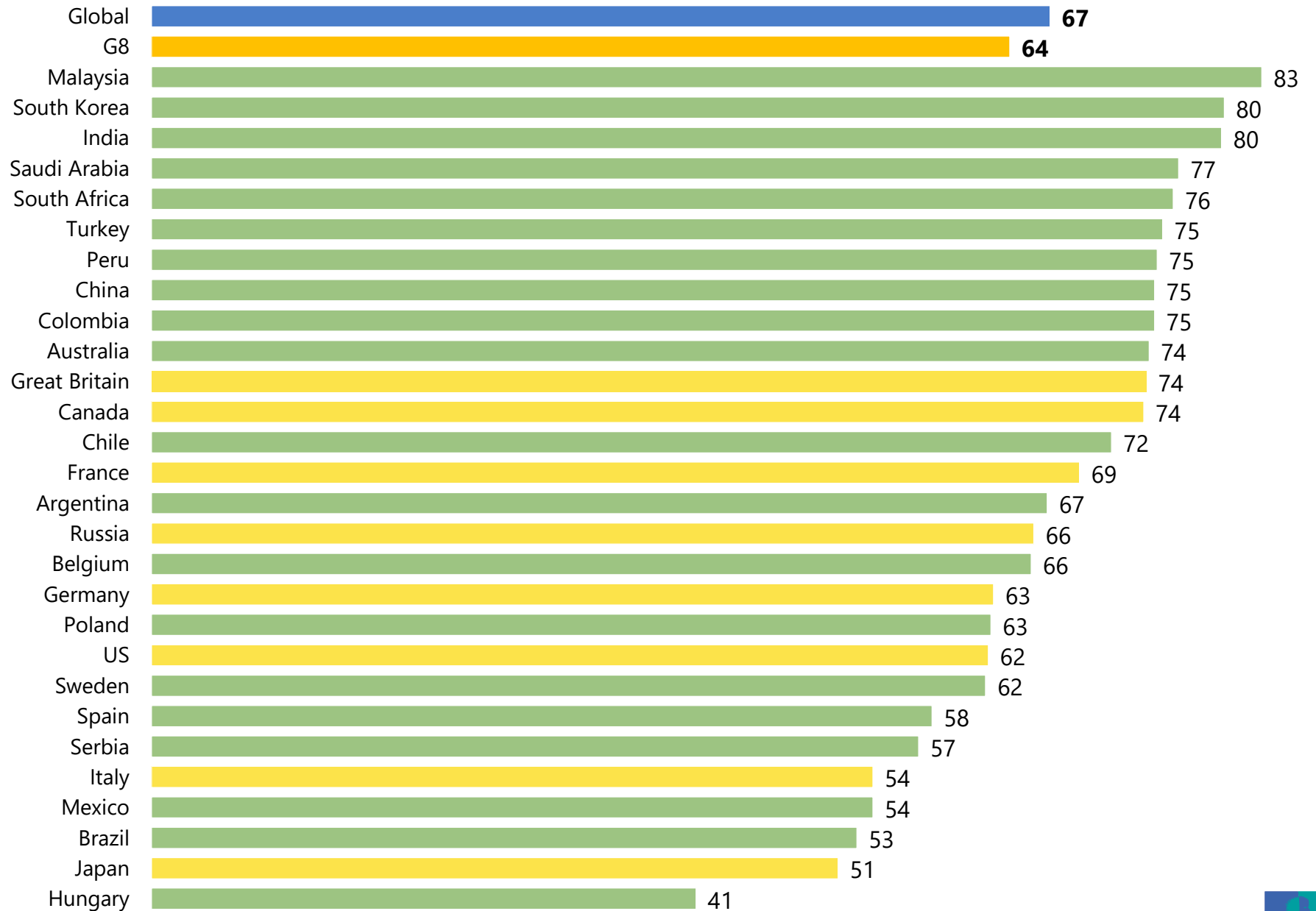

Source: Ipsos/ GIIA

Base: 19,516 adults (online), July-August 2019

Motorways

Q. These next questions are about different types of infrastructure. Please indicate how good or poor you rate the current quality of each one in [COUNTRY]...

**Motorways/
major roads**

% very/fairly good

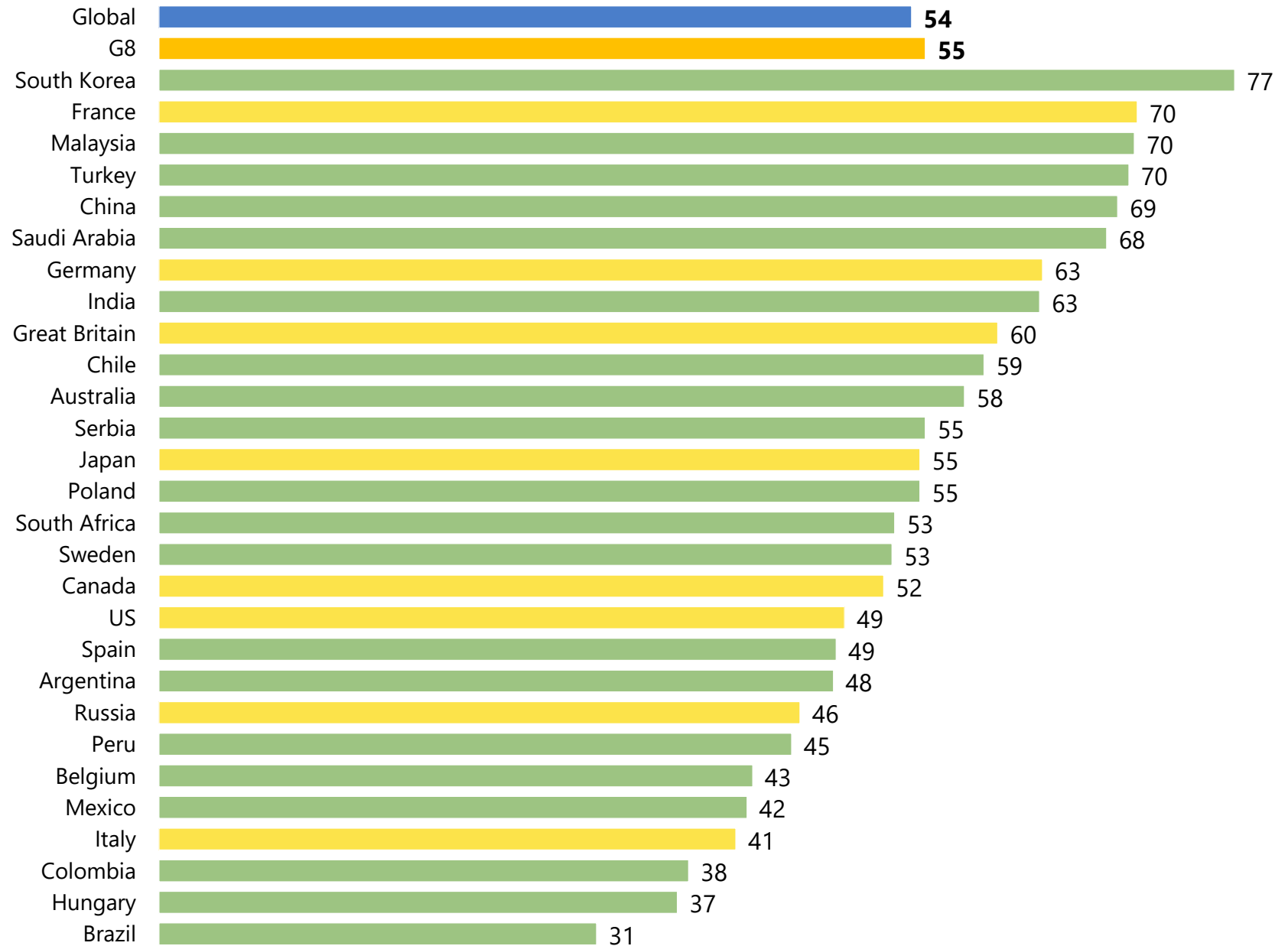

Source: Ipsos/ GIIA Base: 19,516 adults (online), July-August 2019

Local roads

Q. These next questions are about different types of infrastructure. Please indicate how good or poor you rate the current quality of each one in [COUNTRY]...

Local road network

% very/fairly good

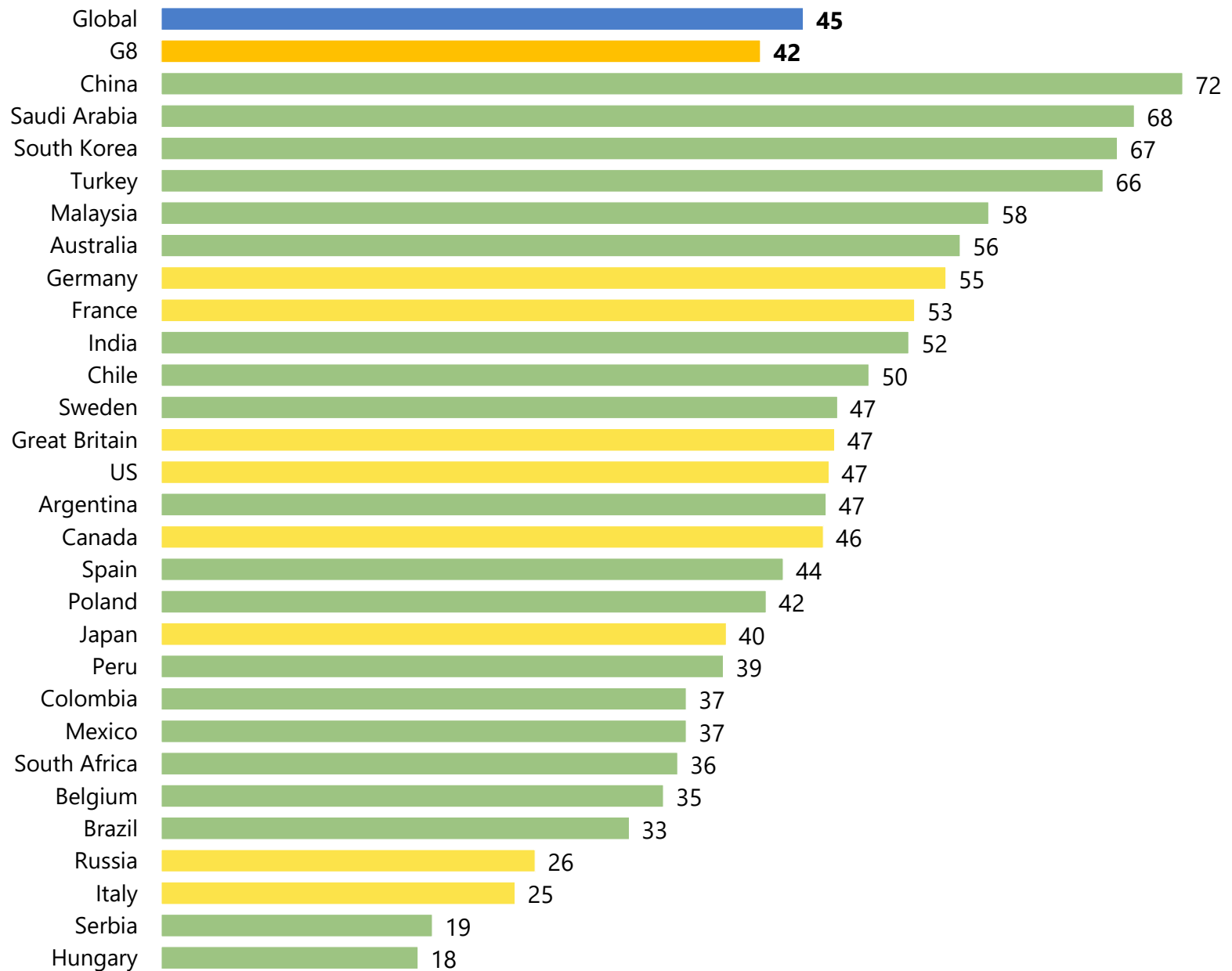

Source: Ipsos/ GIIA Base: 19,516 adults (online), July-August 2019



Rail

Q. These next questions are about different types of infrastructure. Please indicate how good or poor you rate the current quality of each one in [COUNTRY]...

Rail infrastructure (track/stations)

% very/fairly good

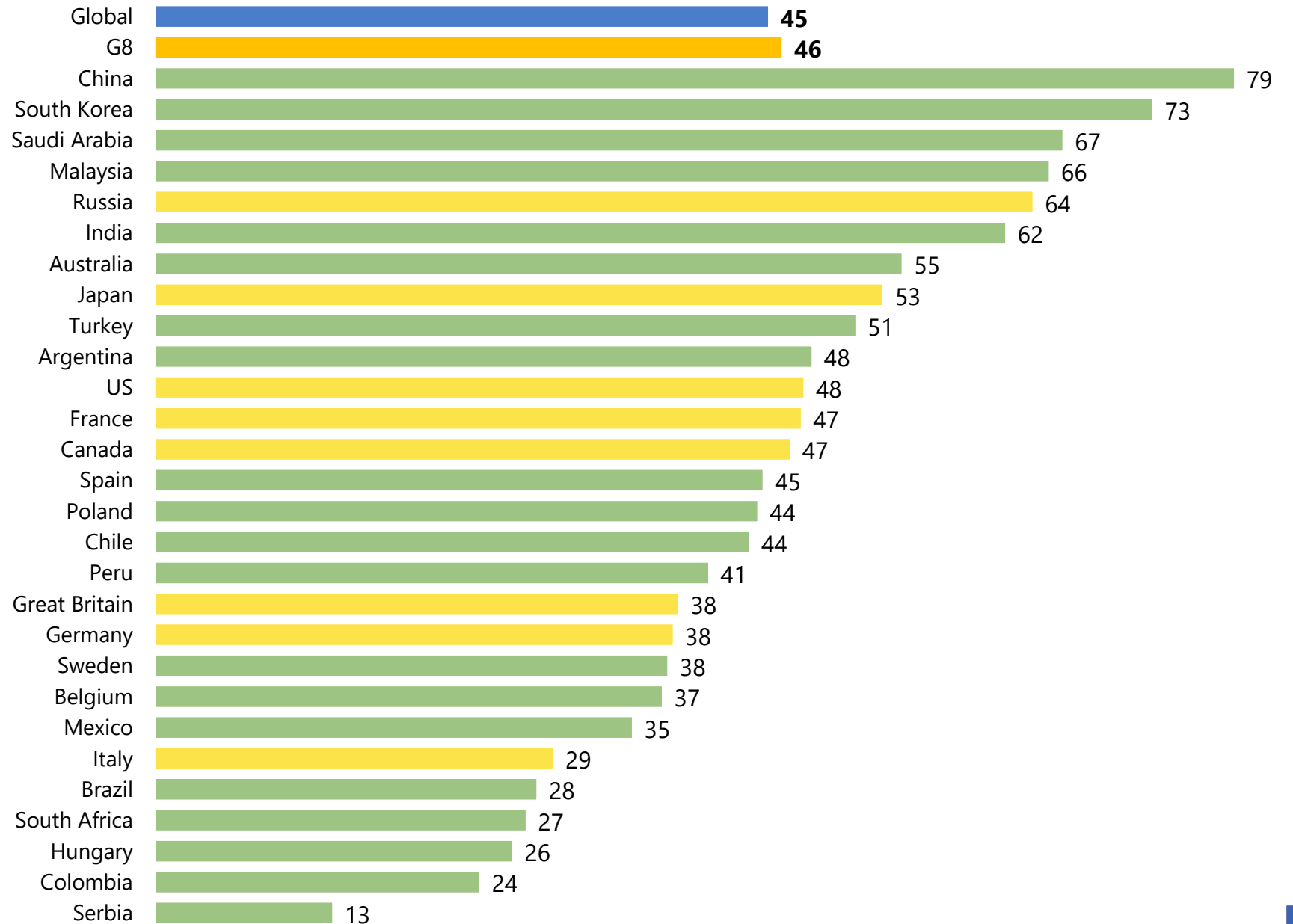

Source: Ipsos/ GIIA Base: 19,516 adults (online), July-August 2019



Housing supply

Q. These next questions are about different types of infrastructure. Please indicate how good or poor you rate the current quality of each one in [COUNTRY]...

New housing supply

% very/fairly good

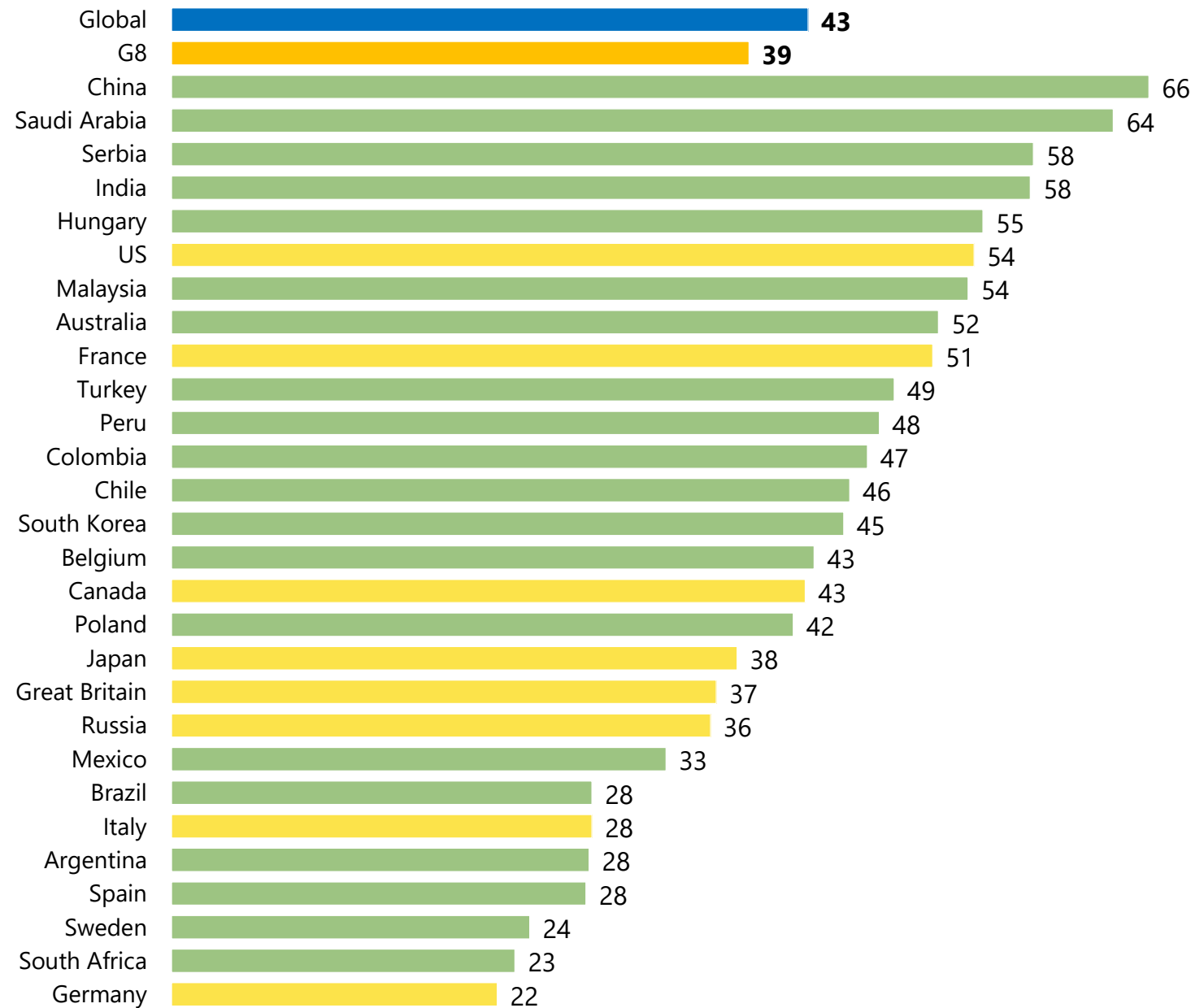

Source: Ipsos/ GIIA Base: 19,516 adults (online), July-August 2019



Flood defences

Q. These next questions are about different types of infrastructure.

Please indicate how good or poor you rate the current quality of each one in [COUNTRY]...

Flood defences

% very/fairly good

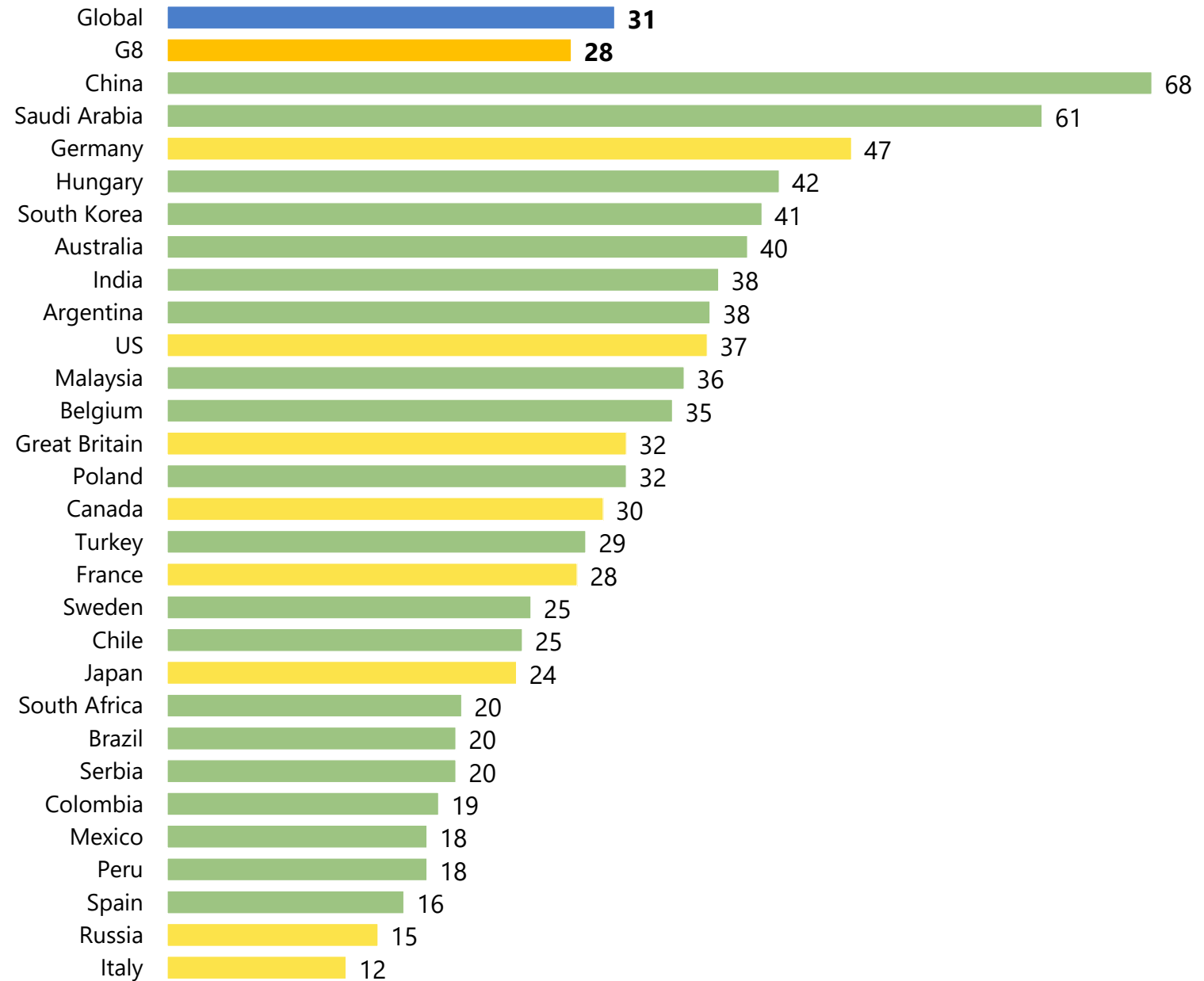

Source: Ipsos/ GIIA Base: 19,516 adults (online), July-August 2019

Solar energy

Q. These next questions are about different types of infrastructure. Please indicate how good or poor you rate the current quality of each one in [COUNTRY]...

Solar energy infrastructure

% very/fairly good

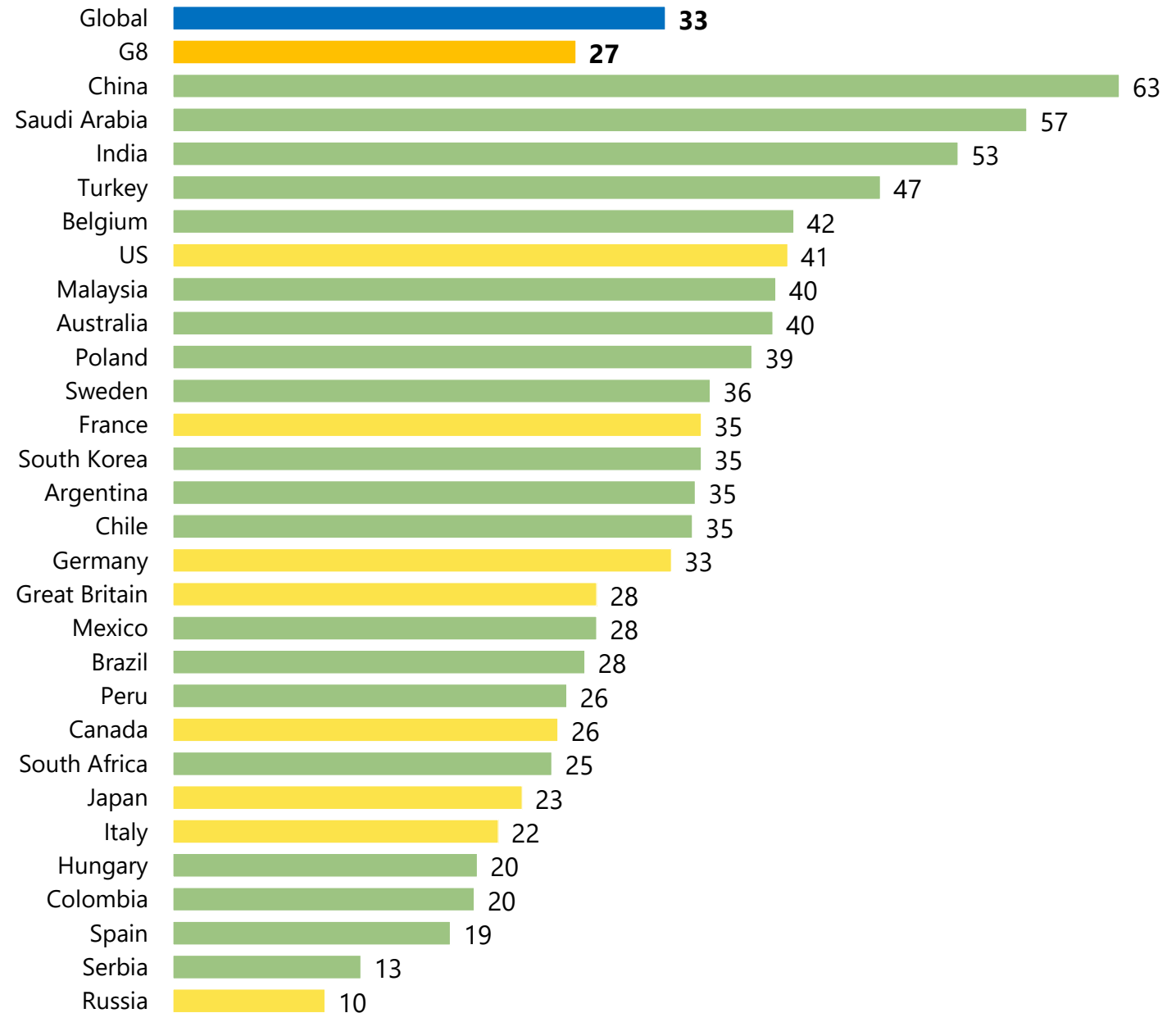

Source: Ipsos/ GIIA Base: 19,516 adults (online), July-August 2019

Nuclear

Q. These next questions are about different types of infrastructure. Please indicate how good or poor you rate the current quality of each one in [COUNTRY]...

Nuclear infrastructure to generate energy

% very/fairly good

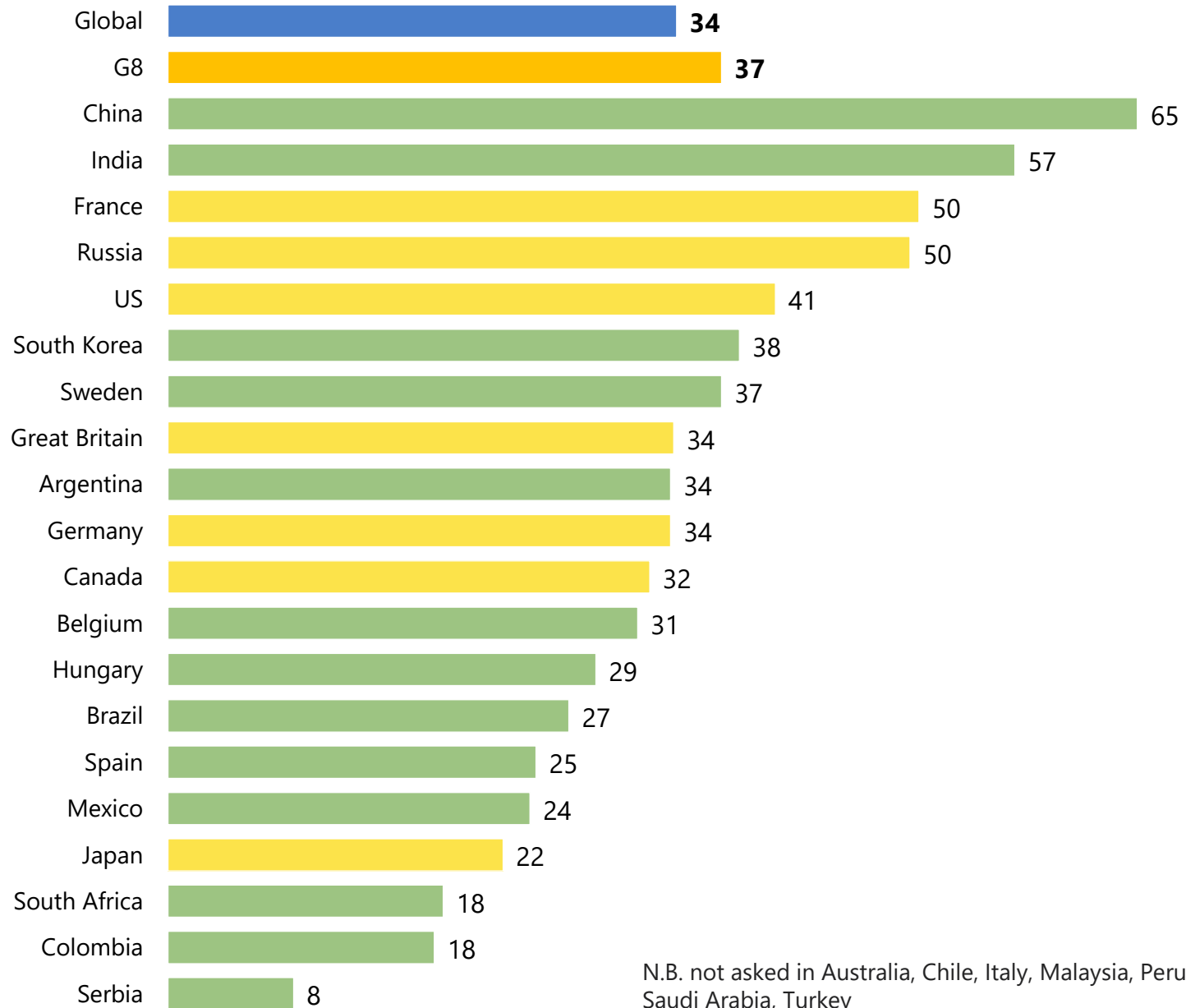

N.B. not asked in Australia, Chile, Italy, Malaysia, Peru, Poland, Saudi Arabia, Turkey

Source: Ipsos/ GIAA Base: 19,516 adults (online), July-August 2019

Digital

Q. These next questions are about different types of infrastructure. Please indicate how good or poor you rate the current quality of each one in [COUNTRY]...

Digital infrastructure such as high speed broadband, full fibre network (FTTP), 5G*

% very/fairly good

* Asked as 'Digital infrastructure such as high speed broadband' in 2016 and 2017

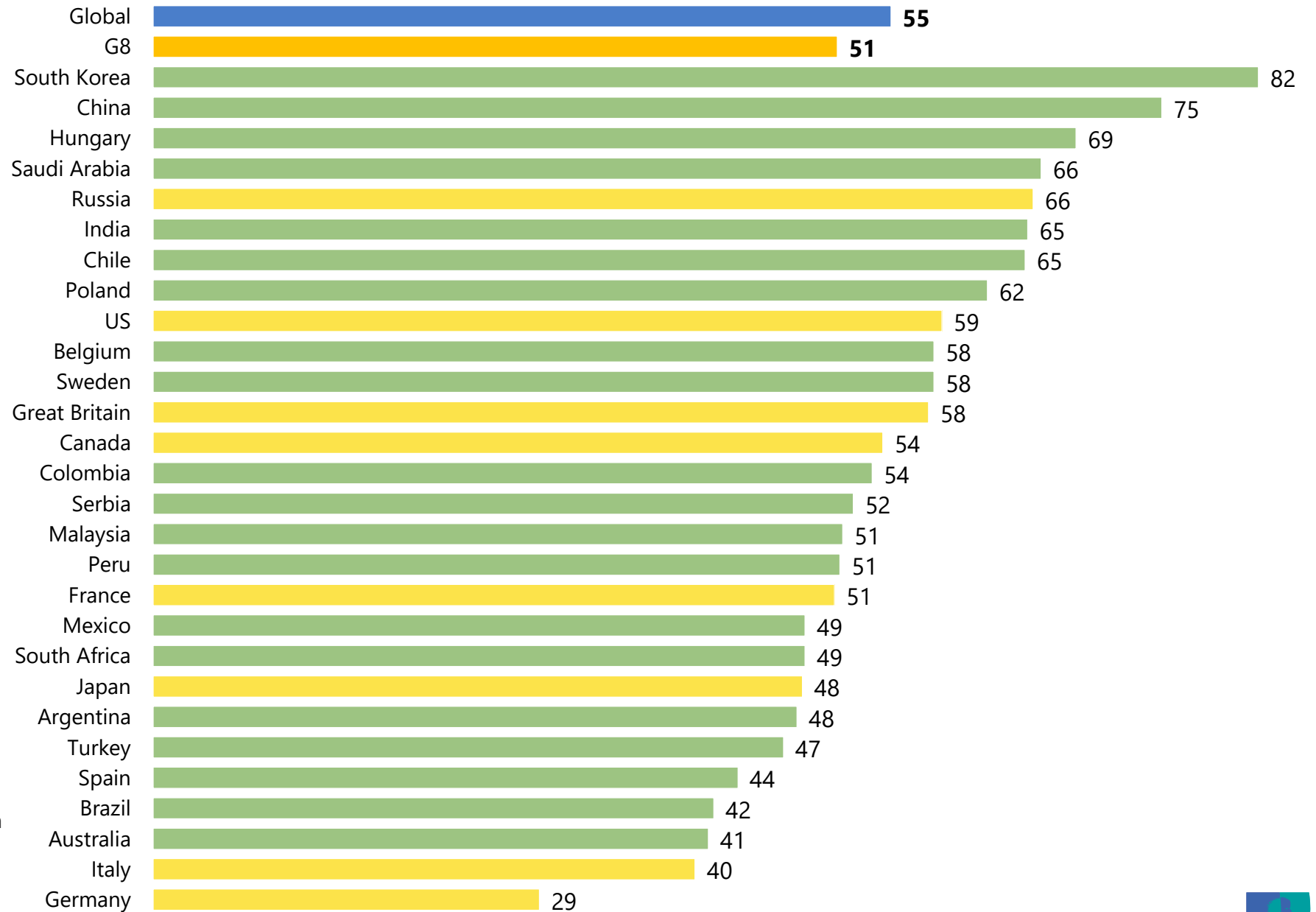

Source: Ipsos/ GIIA Base: 19,516 adults (online), July-August 2019

Water supply

& sewerage

Q. These next questions are about different types of infrastructure. Please indicate how good or poor you rate the current quality of each one in [COUNTRY]...

Water supply and sewerage

% very/fairly good

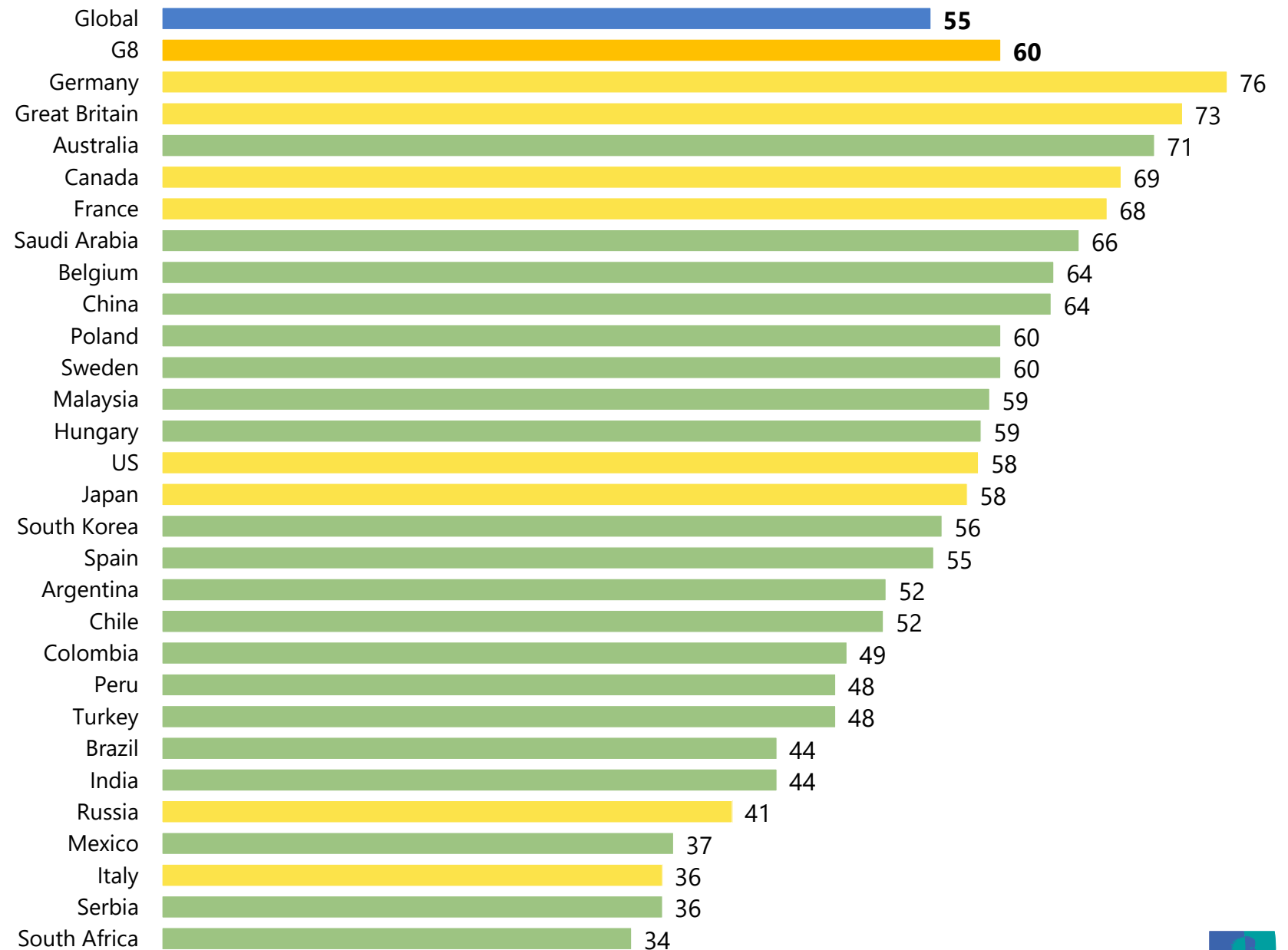

Source: Ipsos/ GIIA

Base: 19,516 adults (online), July-August 2019

Electric vehicle

charging

Q. These next questions are about different types of infrastructure.

Please indicate how good or poor you rate the current quality of each one in [COUNTRY]...

Electric vehicle charging infrastructure

% very/fairly good

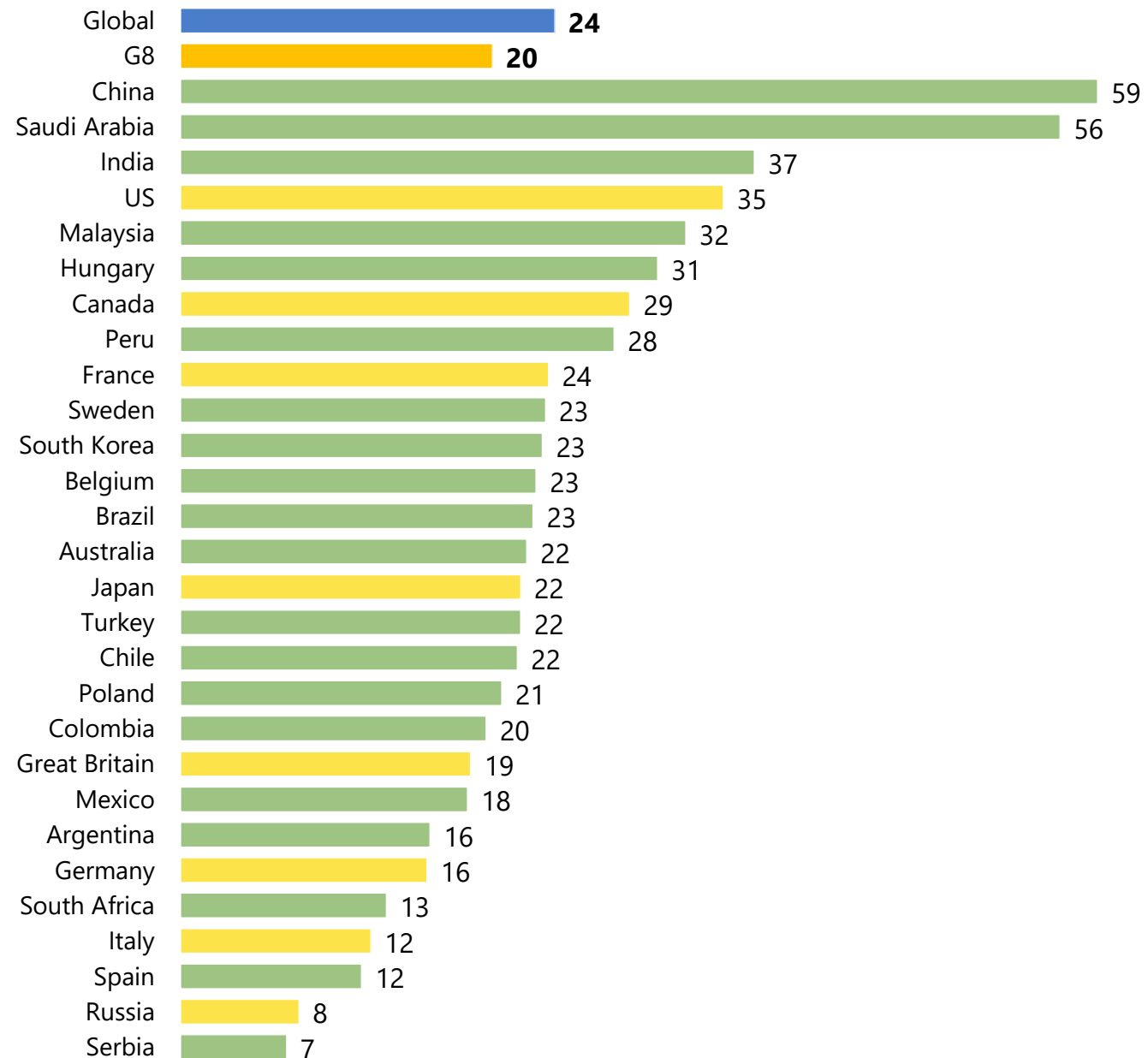

Source: Ipsos/ GIIA Base: 19,516 adults (online), July-August 2019

Wind energy

Q. These next questions are about different types of infrastructure. Please indicate how good or poor you rate the current quality of each one in [COUNTRY]...

Wind energy e.g. turbines

% very/fairly good

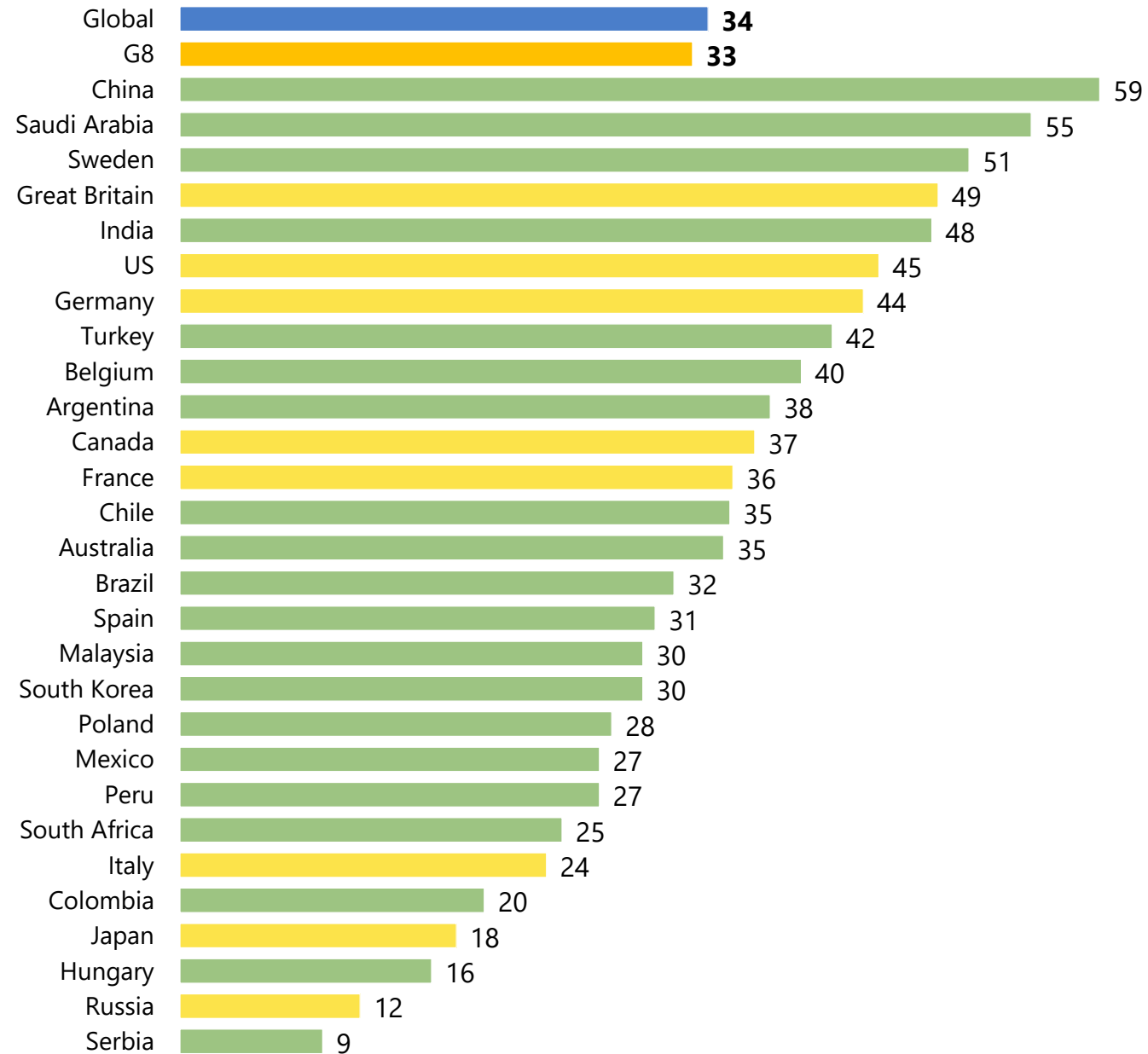

Source: Ipsos/ GIIA Base: 19,516 adults (online), July-August 2019

Cycle facilities

Q. These next questions are about different types of infrastructure. Please indicate how good or poor you rate the current quality of each one in [COUNTRY]...

Please indicate how good or poor you rate the current quality of each one in [COUNTRY]...

Cycle routes/lanes and facilities

% very/fairly good

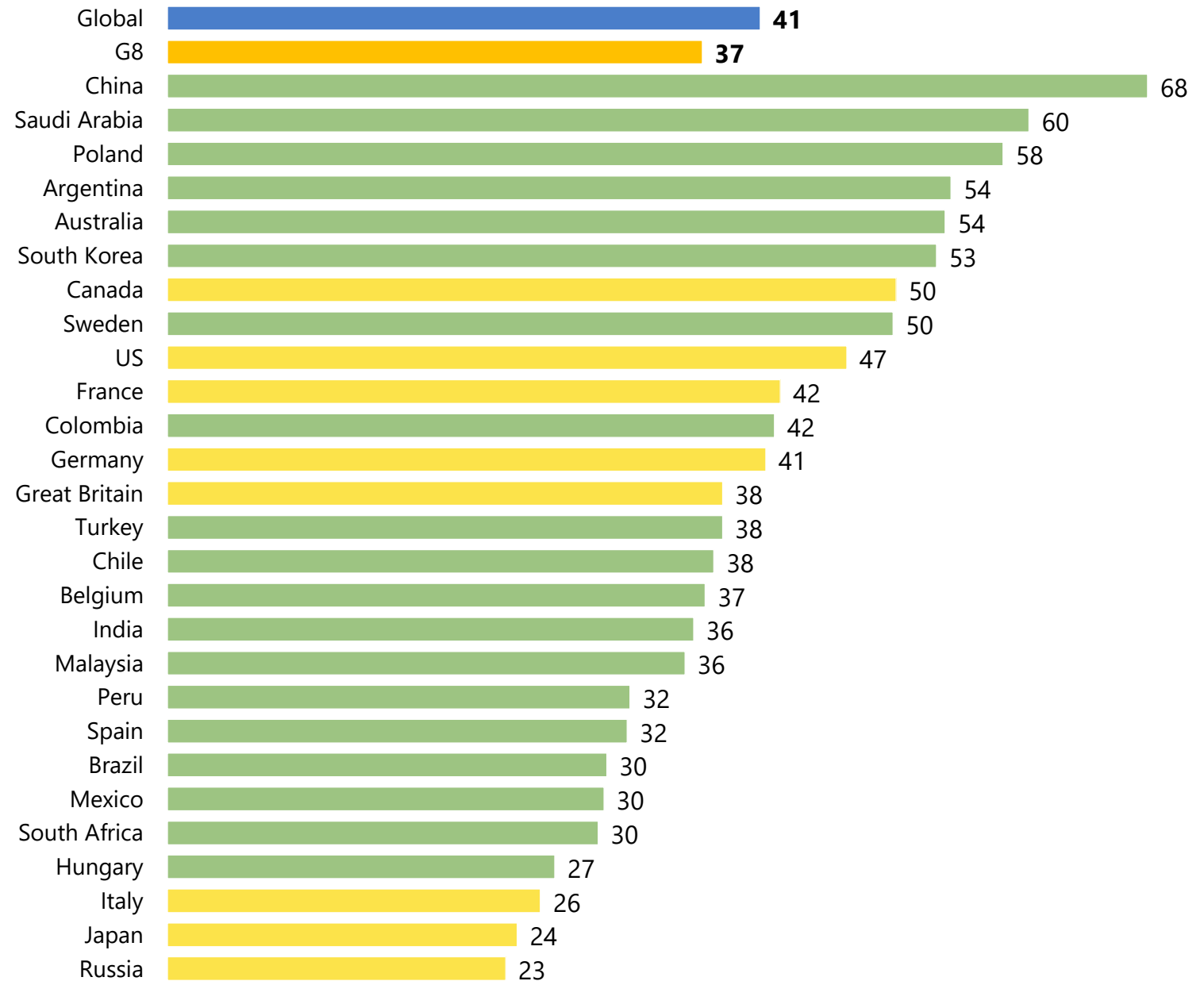

Source: Ipsos/ GIIA Base: 19,516 adults (online), July-August 2019

Pavements, pedestrian

Q. These next questions are about different types of infrastructure. Please indicate how good or poor you rate the current quality of each one in [COUNTRY]...

Pavements, footpaths and pedestrian areas

% very/fairly good

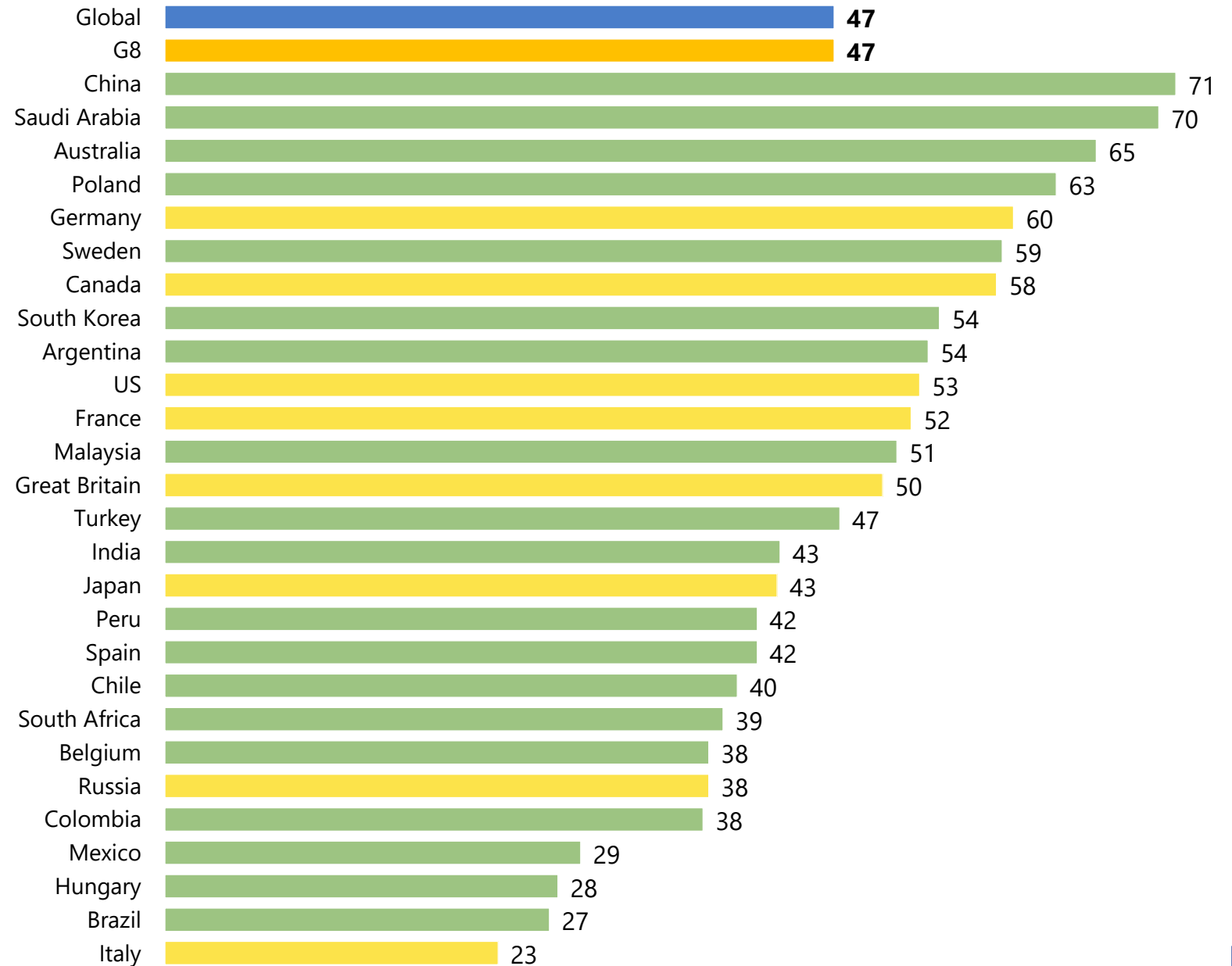

Source: Ipsos/ GIA Base: 19,516 adults (online), Aug 2019





Priorities

Global and G8: Priorities

Q. Which of these types of infrastructure, if any, do you think should be made a priority for investment for... [COUNTRY]?

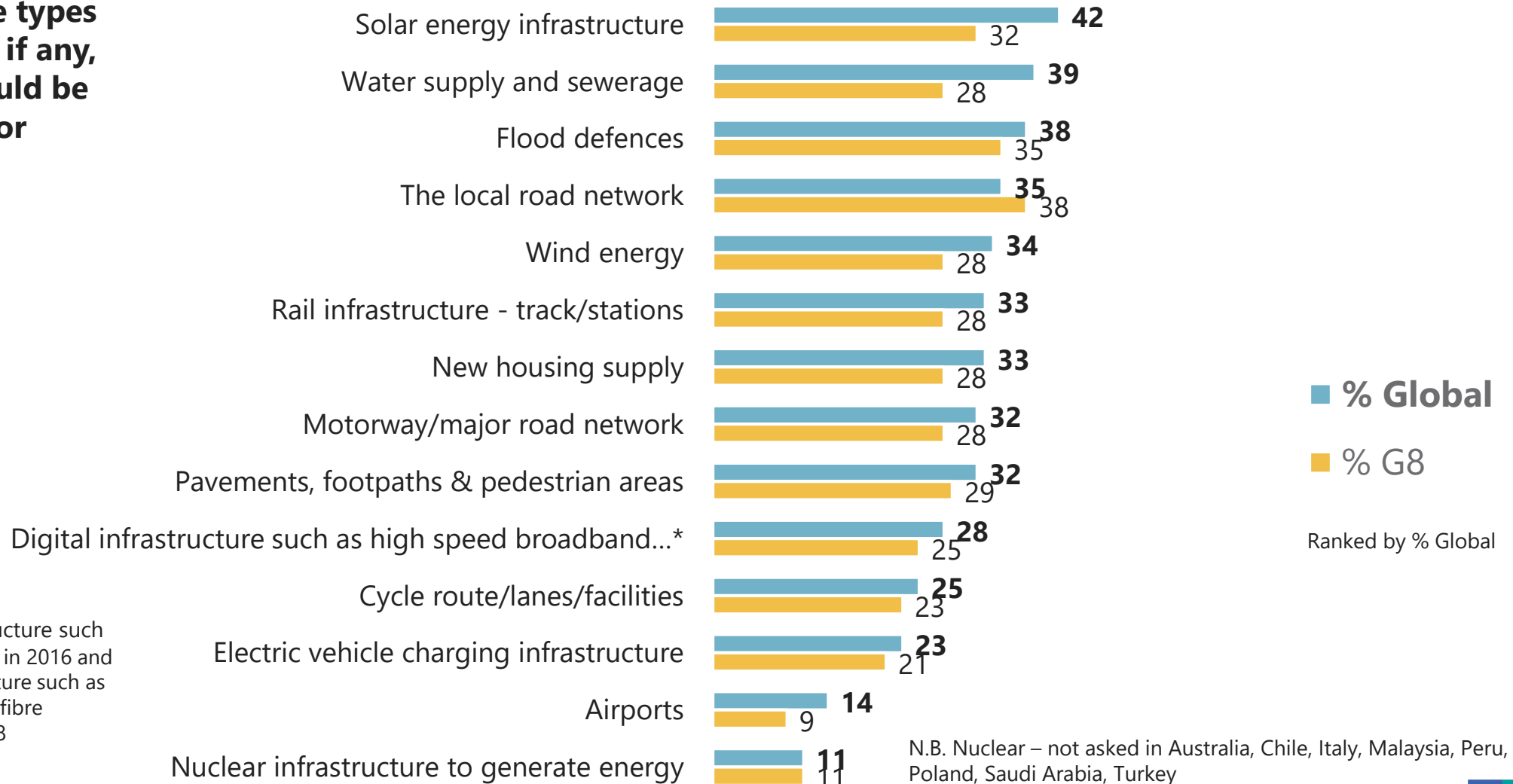

* Asked as 'Digital infrastructure such as high speed broadband' in 2016 and 2017 and 'Digital infrastructure such as high speed broadband, full fibre networks (FTTP), 5G' in 2018

Source: Ipsos/ GIIA Base: 19,516 adults (online), July-August 2019

G8 – Sectors: Ratings v priority

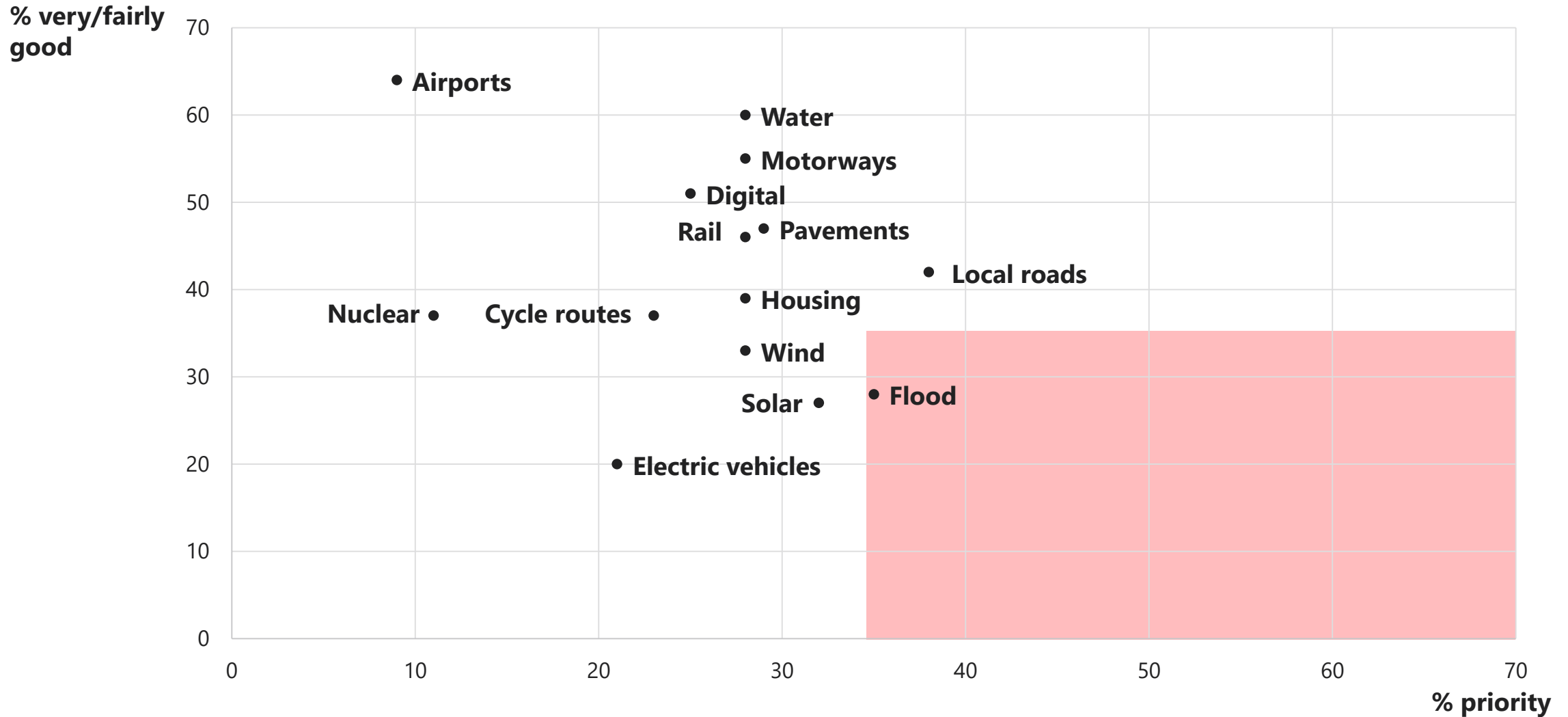

Source: Ipsos/ GIIA Base: 19,516 adults (online), July-August 2019

Trends: Priorities – G8

Q. Which of these types of infrastructure, if any, do you think should be made a priority for investment for... [COUNTRY]?

N.B. confined to sectors included in 2016-2019 i.e. excludes those asked for first time in 2019: pavements, footpaths and pedestrian areas; wind energy; solar infrastructure; cycle routes/lanes and facilities; electric vehicle charging.

The inclusion of these is likely to have reduced mentions for other sectors; trends are not like-for-like.

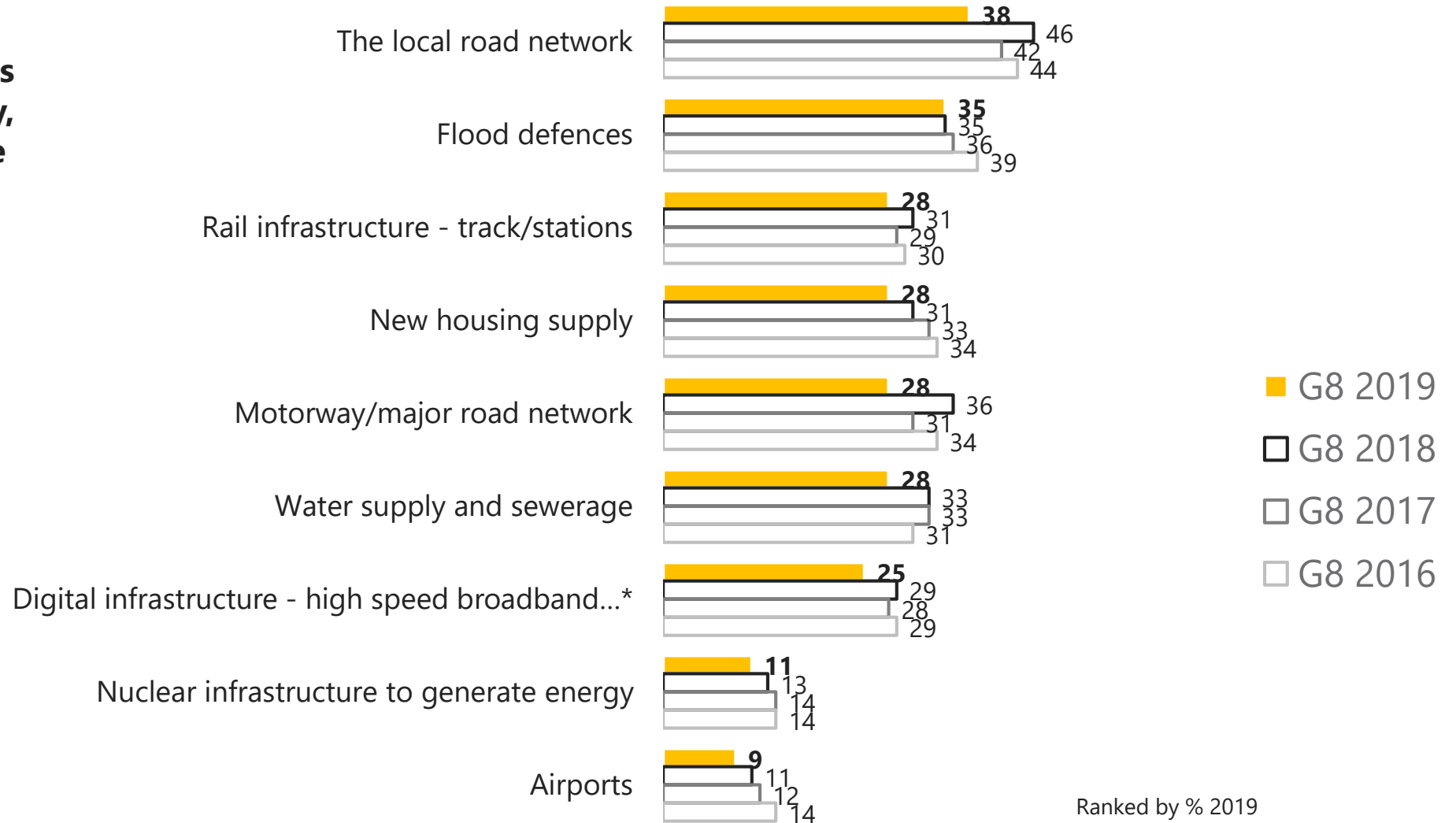

Nuclear – not asked in Australia, Chile, Italy, Malaysia, Peru, Poland, Saudi Arabia, Turkey.

Source: Ipsos/ GIIA Base: 19,516 adults (online), July-August 2019



Trends: Priorities – G8

N.B. confined to sectors included in 2016-2019 i.e. excludes those asked for first time in 2019: pavements, footpaths and pedestrian areas; wind energy; solar infrastructure; cycle routes/lanes and facilities; electric vehicle charging. The inclusion of these is likely to have reduced mentions for other sectors; trends are not like-for-like.

Nuclear – not asked in Australia, Chile, Italy, Malaysia, Peru, Poland, Saudi Arabia, Turkey.

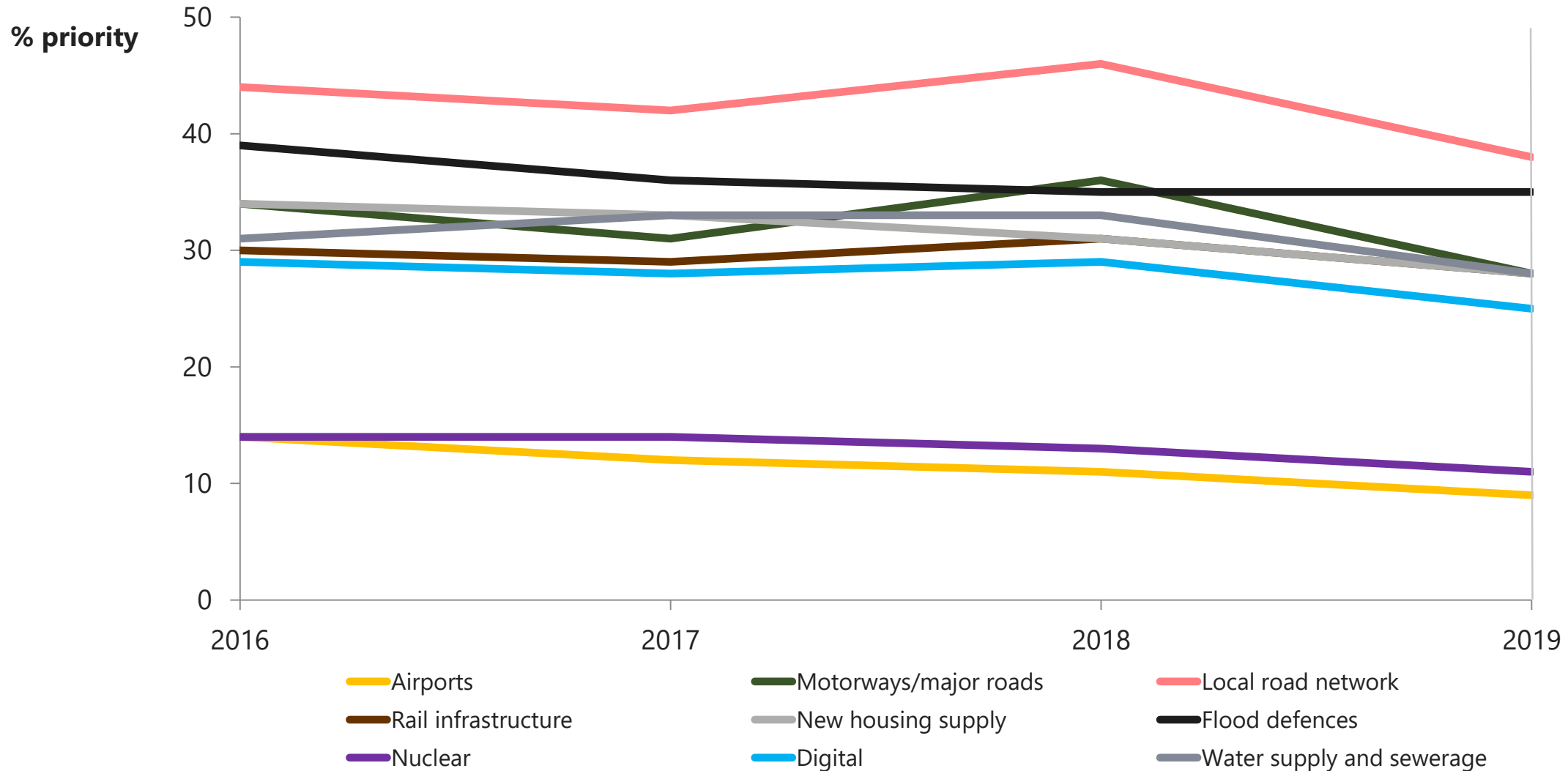

Source: Ipsos/ GIIA Base: 19,516 adults (online), July-August 2019

Future factors

Q. Which of the following factors do you think are the most important for [COUNTRY] to consider when putting together plans for infrastructure in the future? Please rank the following...

% ranking factor as most important (1st out of 7)

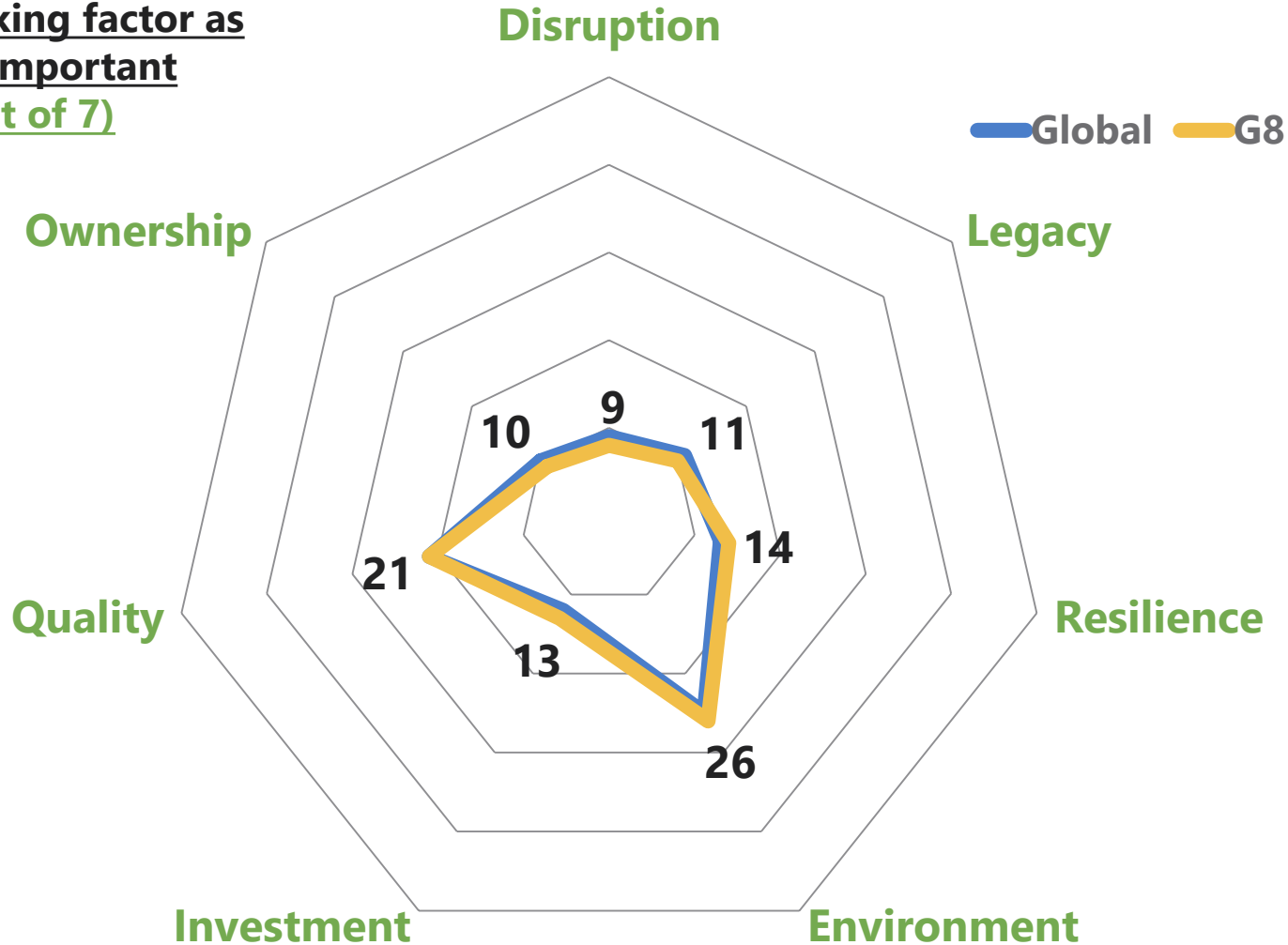

Source: Ipsos/ GIIA

Base: 19,516 adults (online), July-August 2019

Factor

Disruption: the amount of disruption we have to deal with (e.g. roadworks, disruptions to water supply) while infrastructure is built or improved

Legacy: the infrastructure that we pass on to future generations

Resilience: how well our infrastructure stands up to challenges today and in the future (e.g. population increases and climate change)

Environment: the impact our infrastructure has on our environment

Investment: paying for the costs of improving and building new infrastructure now, to avoid having to pay more later

Quality: making sure that infrastructure is as good as it possibly can be (e.g. in terms of speed or convenience of services)

Ownership: whether the infrastructure is owned by the public sector – that is, national or local government or some other public sector body – or private businesses

Future factors

Q. Which of the following factors do you think are the most important for [COUNTRY] to consider when putting together plans for infrastructure in the future? Please rank the following...

% ranking factor as most important
(7th out of 7)

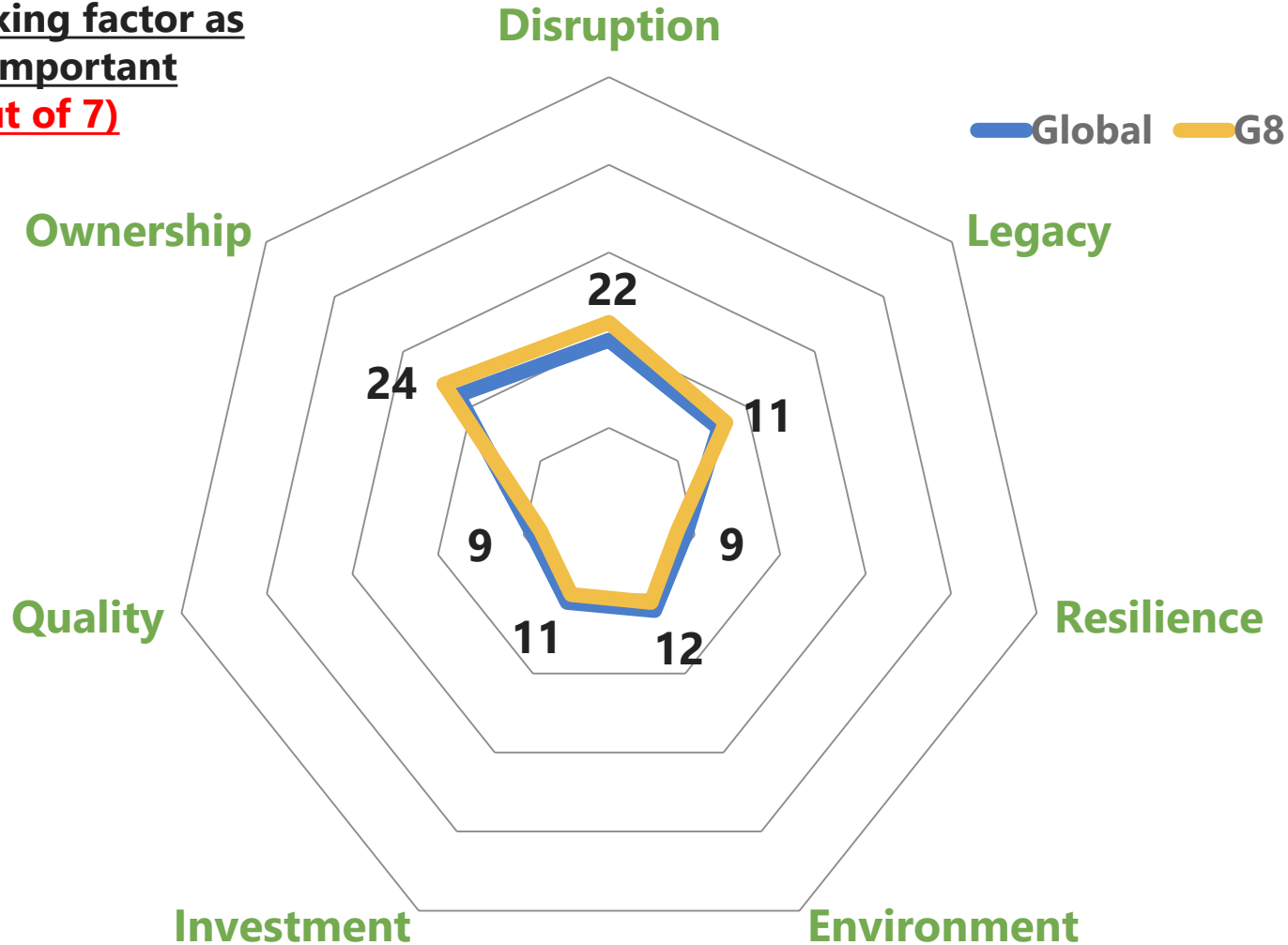

Factor

Disruption: the amount of disruption we have to deal with (e.g. roadworks, disruptions to water supply) while infrastructure is built or improved

Legacy: the infrastructure that we pass on to future generations

Resilience: how well our infrastructure stands up to challenges today and in the future (e.g. population increases and climate change)

Environment: the impact our infrastructure has on our environment

Investment: paying for the costs of improving and building new infrastructure now, to avoid having to pay more later

Quality: making sure that infrastructure is as good as it possibly can be (e.g. in terms of speed or convenience of services)

Ownership: whether the infrastructure is owned by the public sector – that is, national or local government or some other public sector body – or private businesses

Source: Ipsos/ GIIA

Base: 19,516 adults (online), July-August 2019

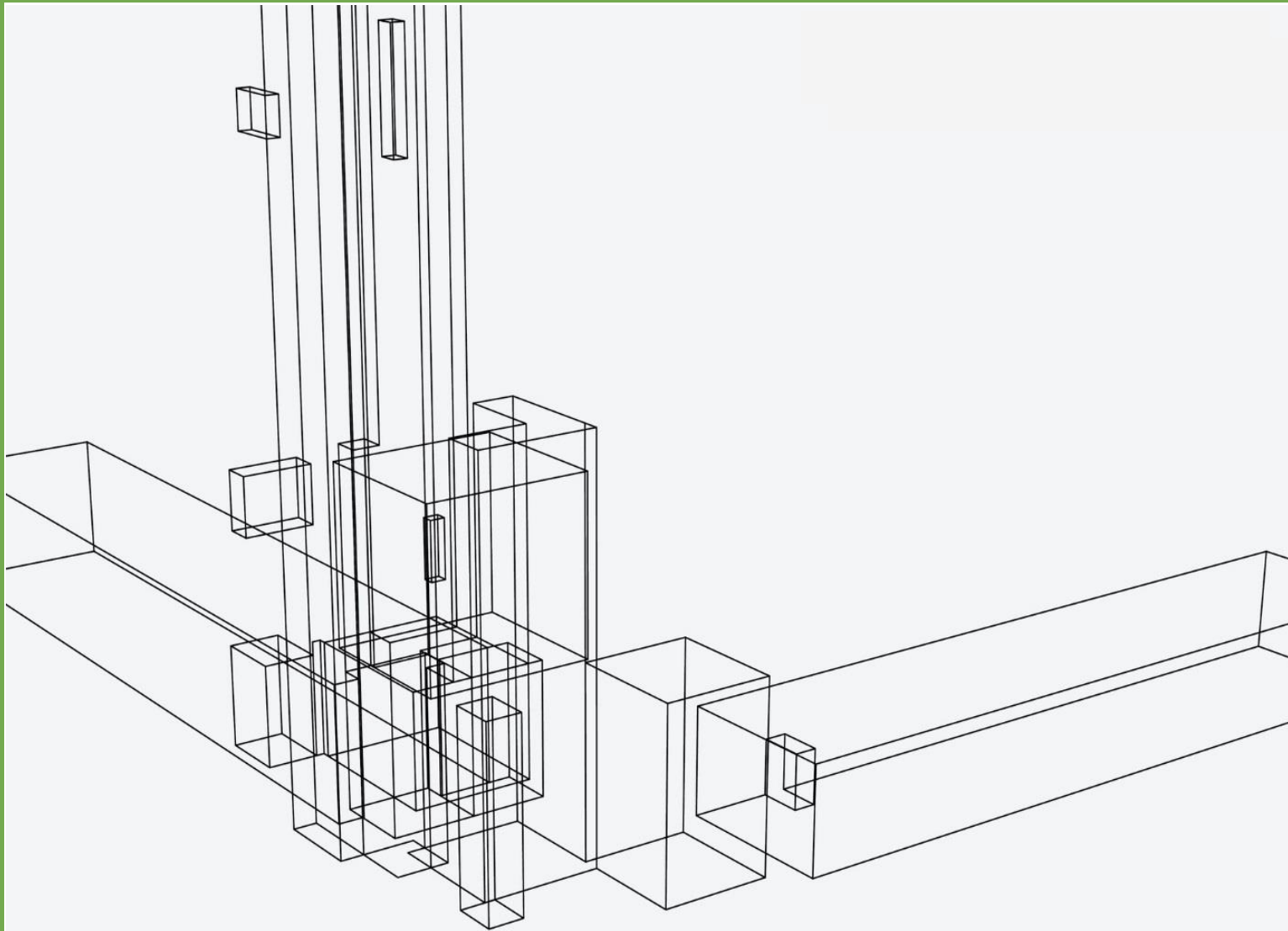

Attitudes

Global: Attitudes

Q. To what extent do you agree or disagree...?

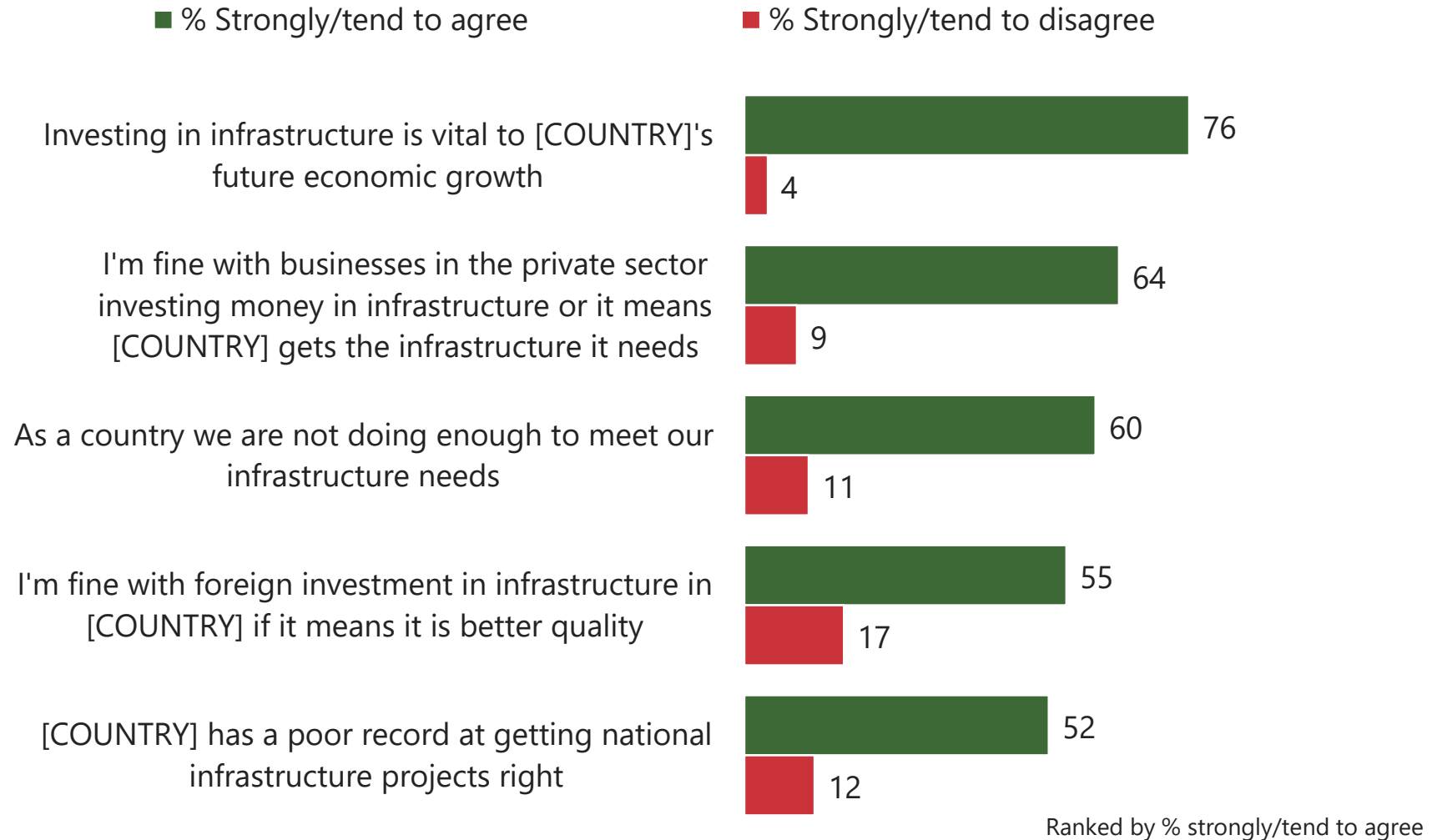

Source: Ipsos/ GIAA

Base: 19,516 adults (online), July-August 2019



G8: Attitudes

Q. To what extent do you agree or disagree...?

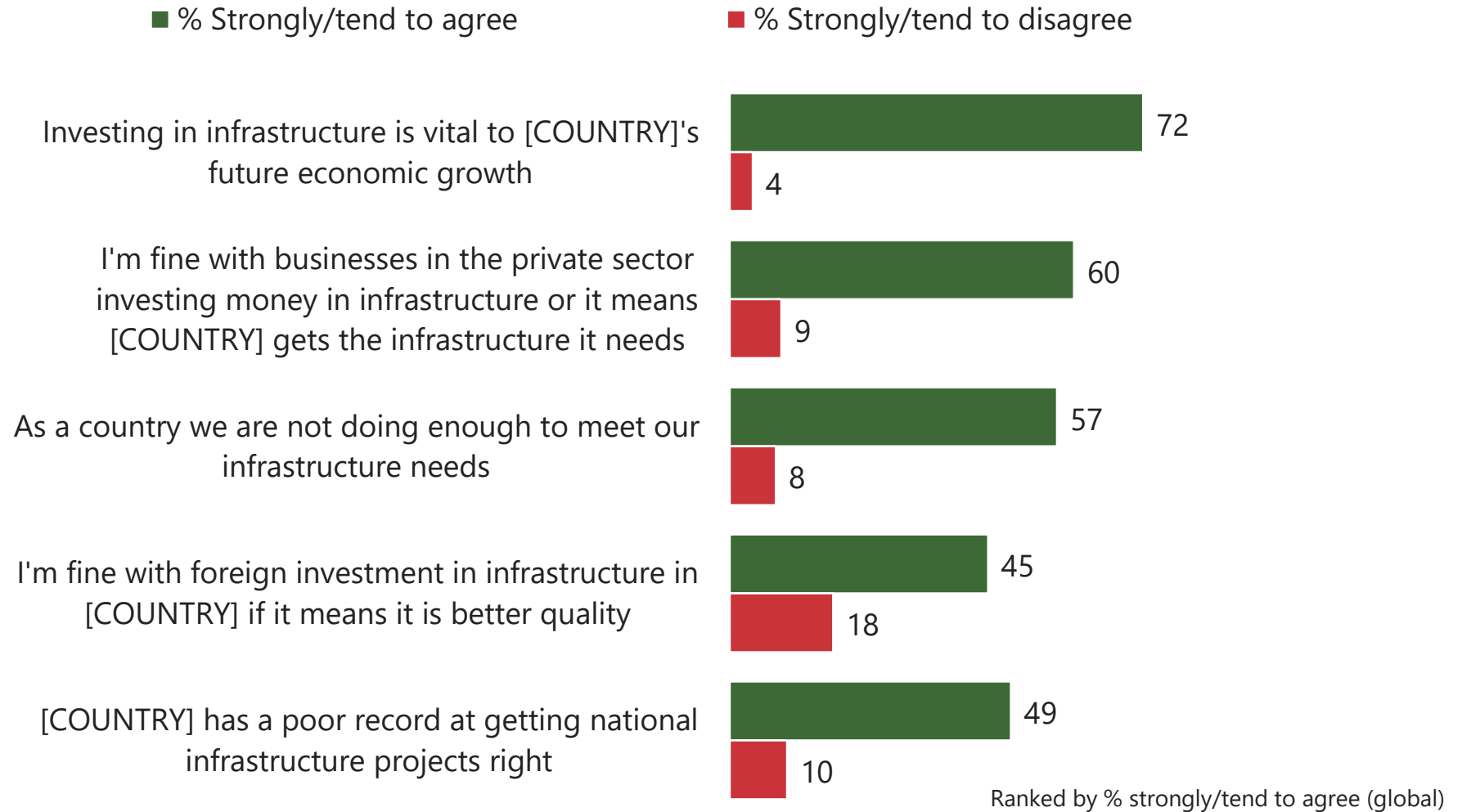

Source: Ipsos/ GIIA Base: 19,516 adults (online), July-August 2019

Doing enough?

Q. To what extent do you agree or disagree...?

As a country we are not doing enough to meet our infrastructure needs

% strongly/tend to agree

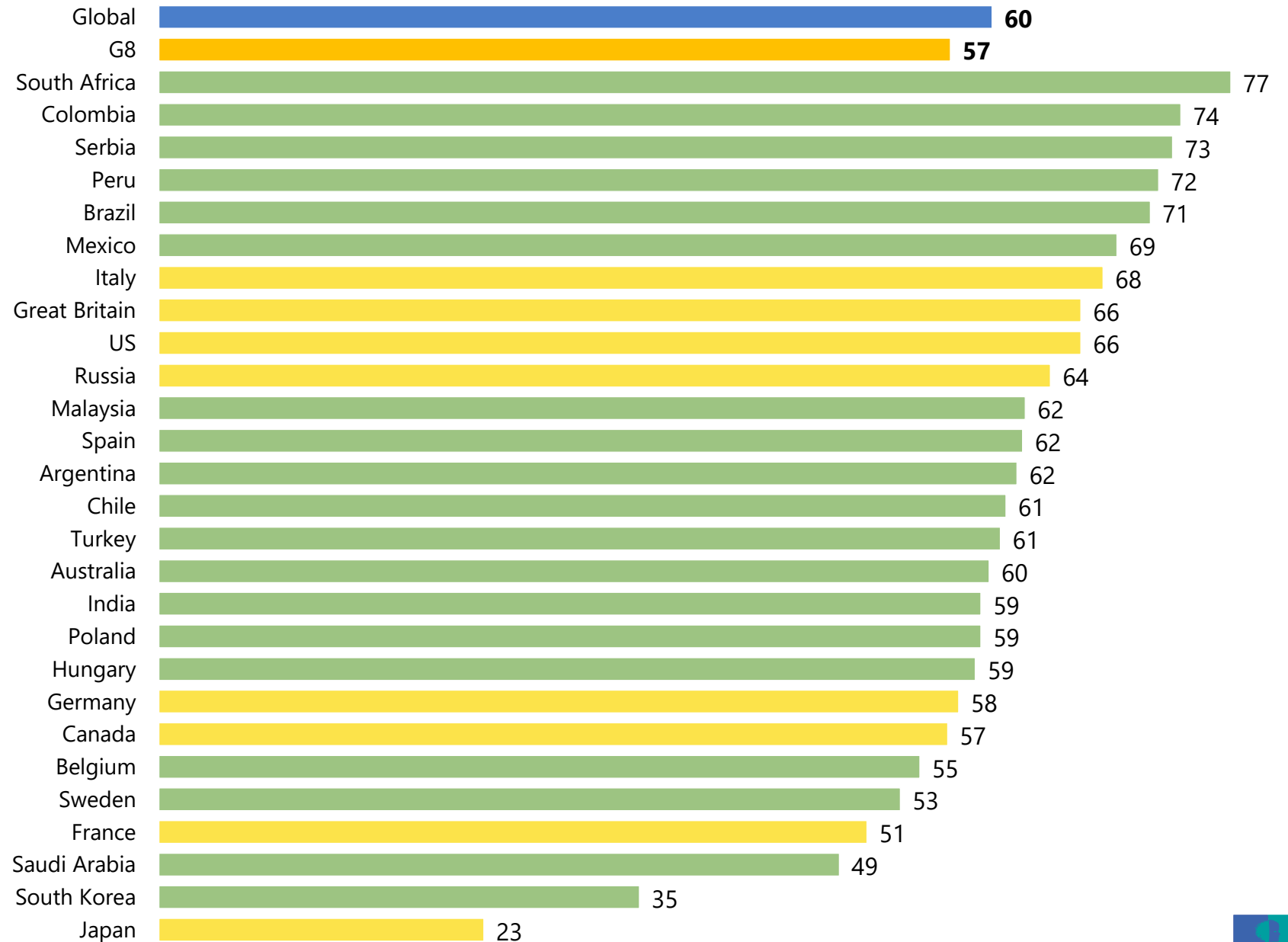

Source: Ipsos/ GIIA Base: 19,516 adults (online), July-August 2019



Investment vital

Q. To what extent do you agree or disagree...?

Investing in infrastructure is vital to [COUNTRY]'s future economic growth

% strongly/tend to agree

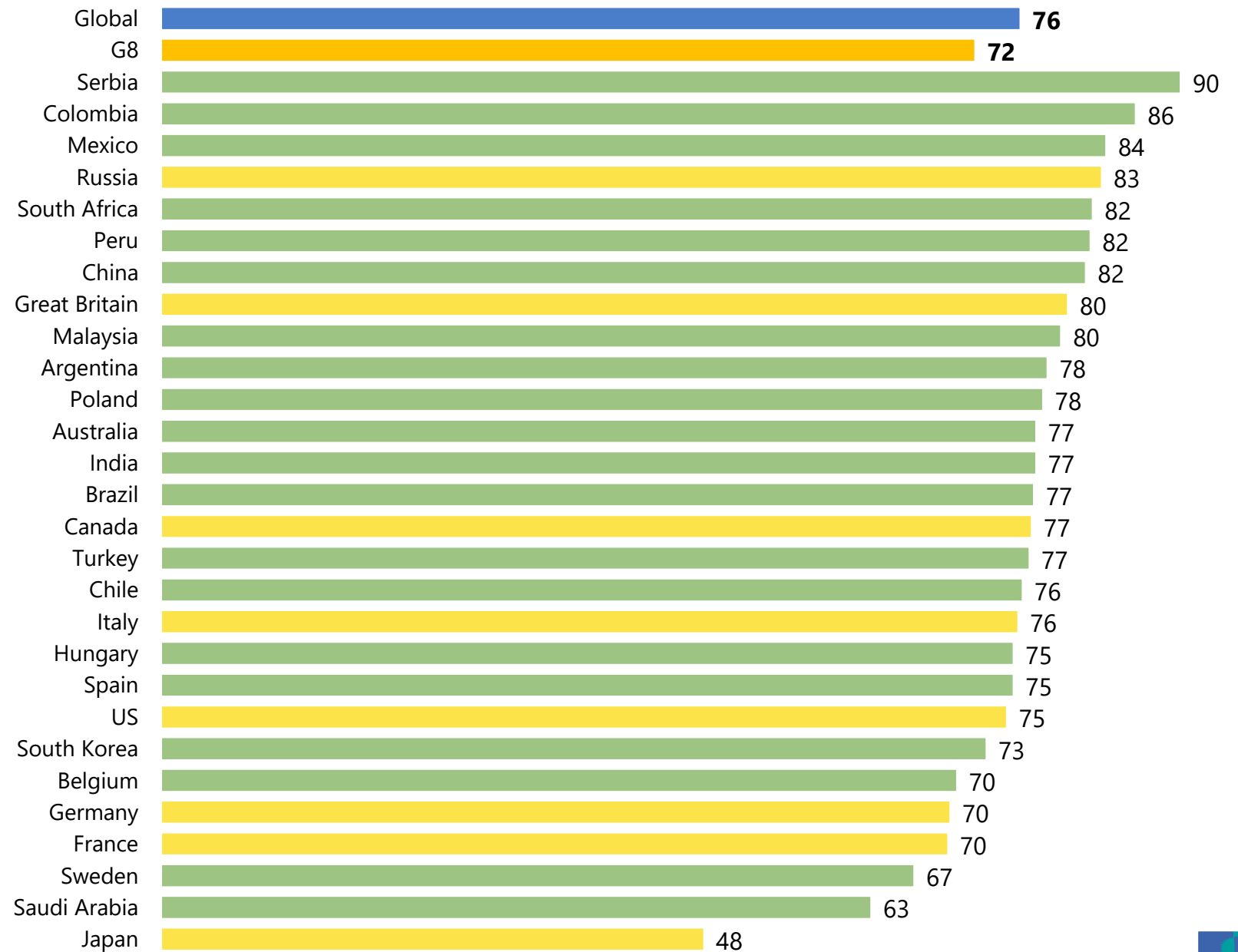

Source: Ipsos/ GIIA Base: 19,516 adults (online), July-August 2019



Poor record

Q. To what extent do you agree or disagree...?

[COUNTRY] has a poor record at getting national infrastructure projects right

% strongly/tend to agree

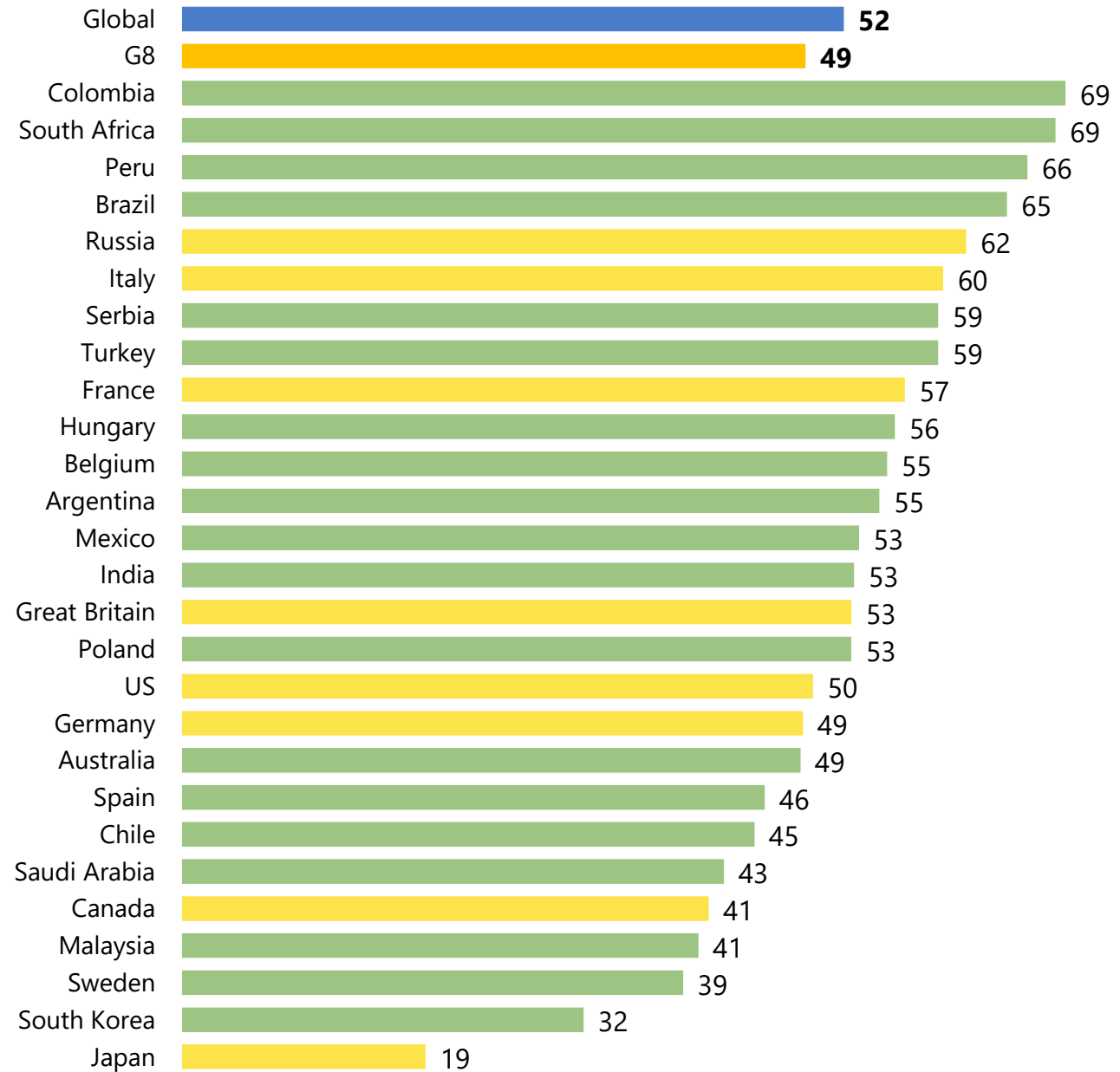

Source: Ipsos/ GIAA Base: 19,516 adults (online), July-August 2019

Foreign investment

Q. To what extent do you agree or disagree...?

I'm fine with foreign investment in new infrastructure in [COUNTRY] if it means it is better quality

% strongly/tend to agree

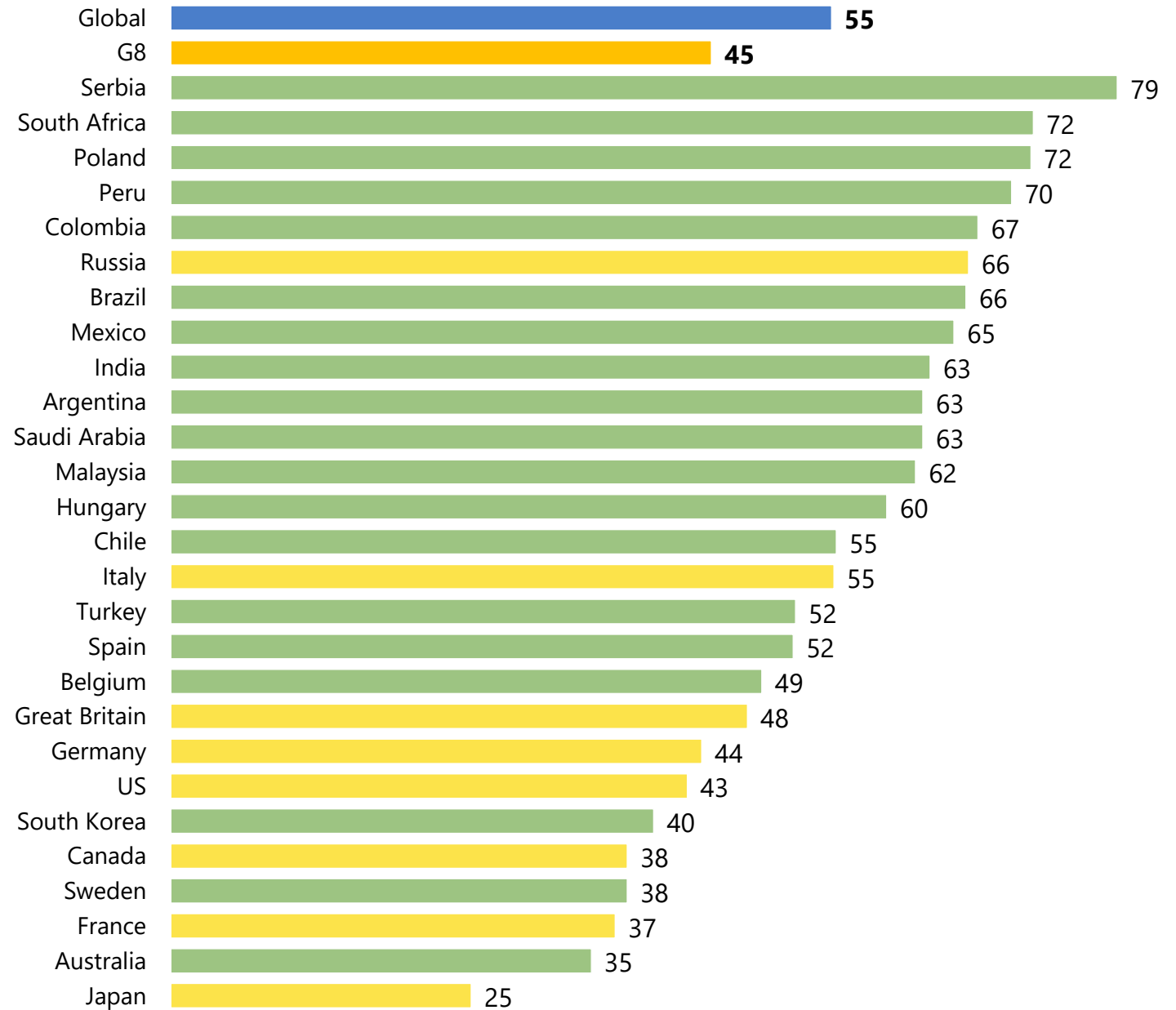

Source: Ipsos/ GIIA Base: 19,516 adults (online), July-August 2019

Private investment

Q. To what extent do you agree or disagree...?

I'm fine with businesses in the private sector investing money in infrastructure if it means [COUNTRY] gets the infrastructure it needs

% strongly/tend to agree

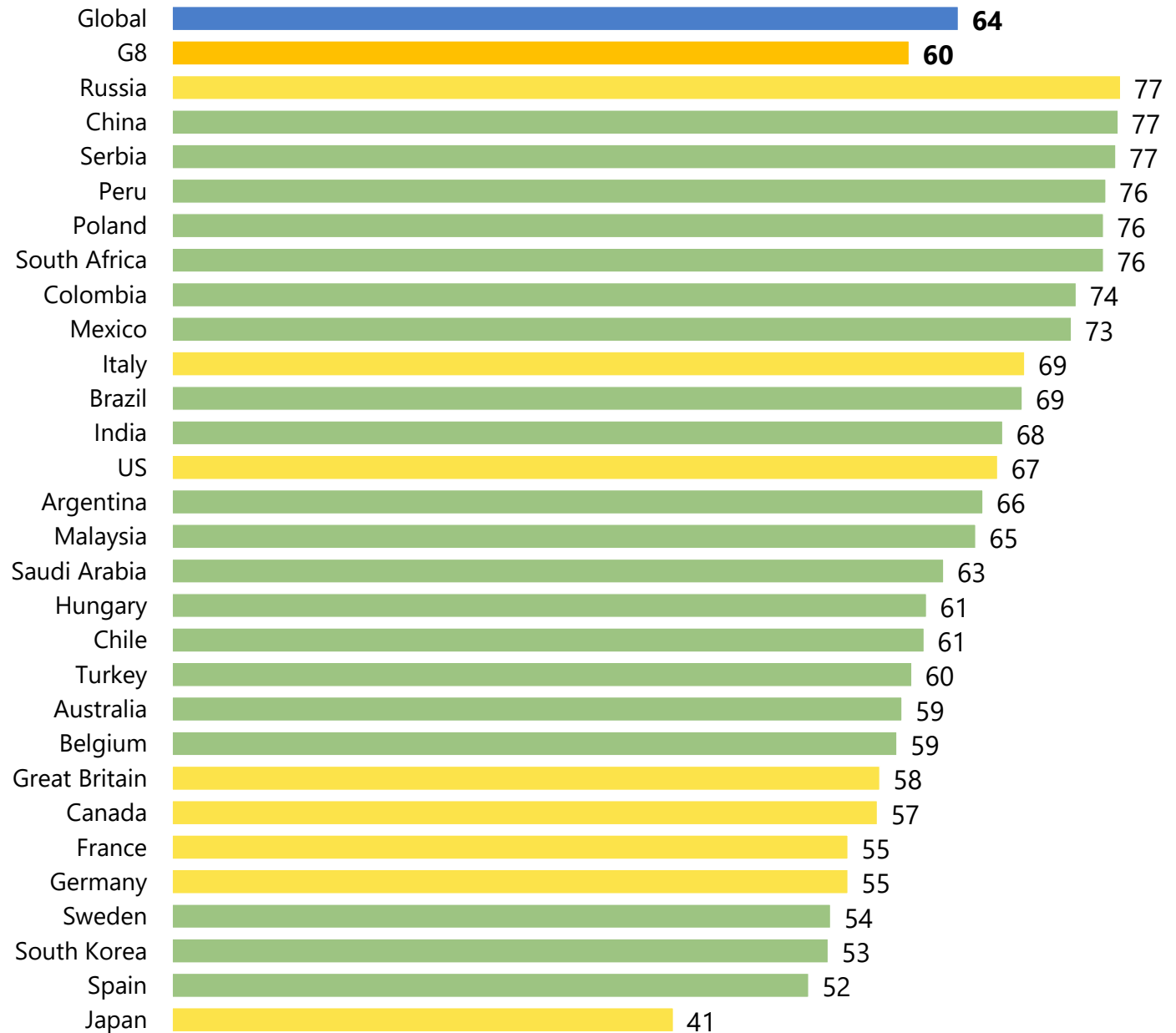

Source: Ipsos/ GIA Base: 19,516 adults (online), July-August 2019

Who takes decisions?

A: "Politicians should mostly make decisions about new infrastructure projects because they are accountable to the public."

% STRONGLY/TEND TO PREFER EACH STATEMENT



B: "Technical experts should mostly make decisions about new infrastructure projects because they know more about what [COUNTRY] needs."

■ Global ■ G8

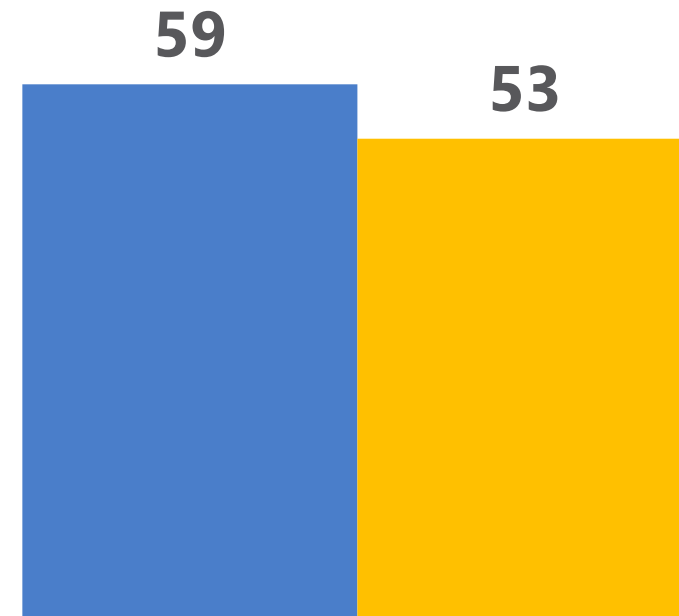

Source: Ipsos/ GIIA Base: 19,516 adults (online), July-August 2019

Increase taxes or borrowing?

A: "Spending on improving infrastructure in [COUNTRY] should be increased, even if that means higher taxes or more government borrowing"

% STRONGLY/TEND TO PREFER EACH STATEMENT

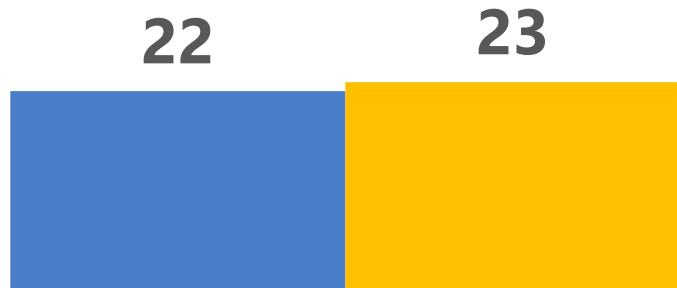

B: "Public spending in [COUNTRY] is already high and taxes and government borrowing should not be increased any more to spend more on improving infrastructure"

■ Global ■ G8

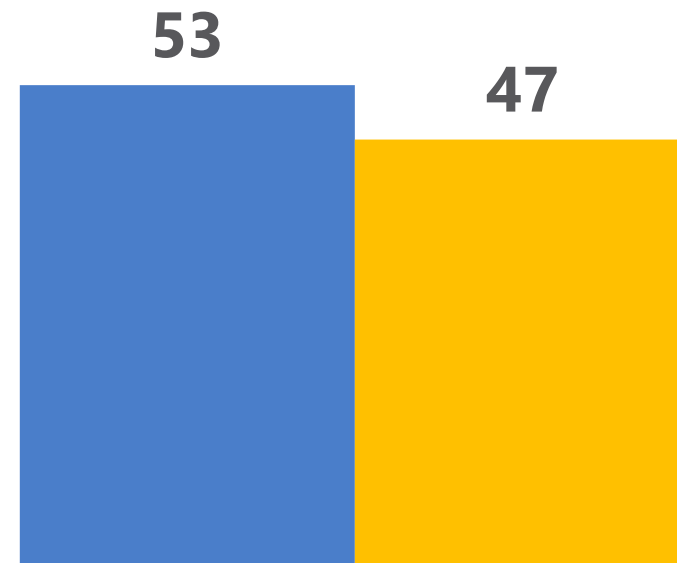

Source: Ipsos/ GIIA

Base: 19,516 adults (online), July-August 2019

Maintain/repair or new?

A: “We should prioritise maintaining and repairing existing infrastructure in [COUNTRY] before spending on new infrastructure”

% STRONGLY/TEND TO PREFER EACH STATEMENT

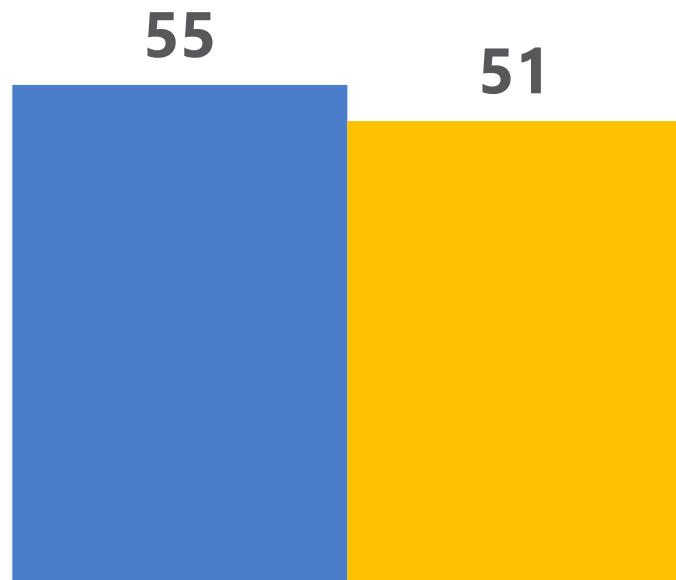

B: “We need to spend money on new infrastructure in [COUNTRY] even if it means having less to spend less on maintaining and repairing existing infrastructure”

■ Global ■ G8



Source: Ipsos/ GIIA Base: 19,516 adults (online), July-August 2019

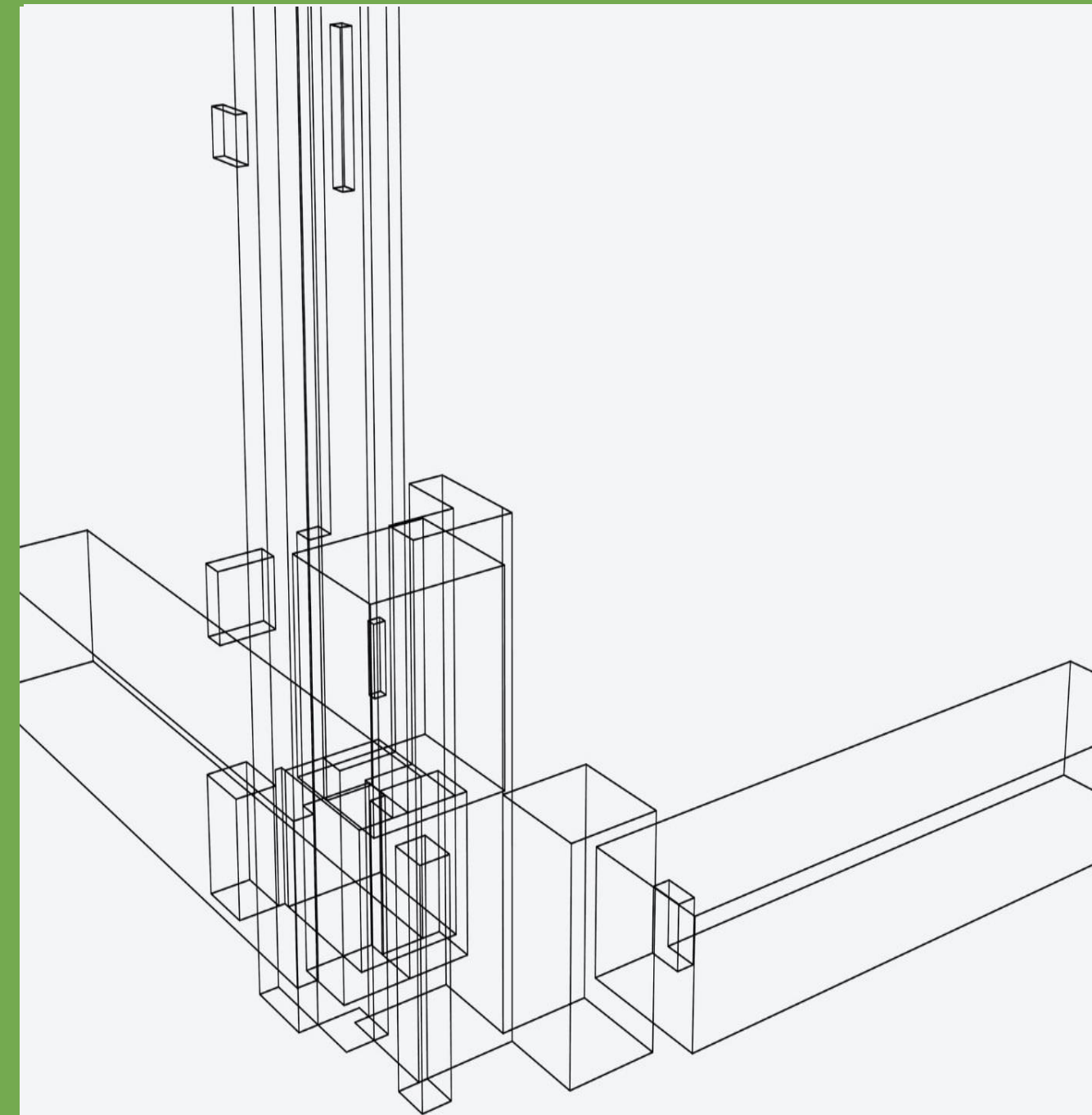

'Nimbyism'

'Nimbyism'

Q. To what extent do you support or oppose, in principle, the building of new infrastructure in your local area. Again by infrastructure, we mean things we rely on like road, rail and air networks, utilities such as energy and water, and broadband and other communications. By local area we mean the area within 15-20 minutes' walk from where you live.

% strongly/tend to support

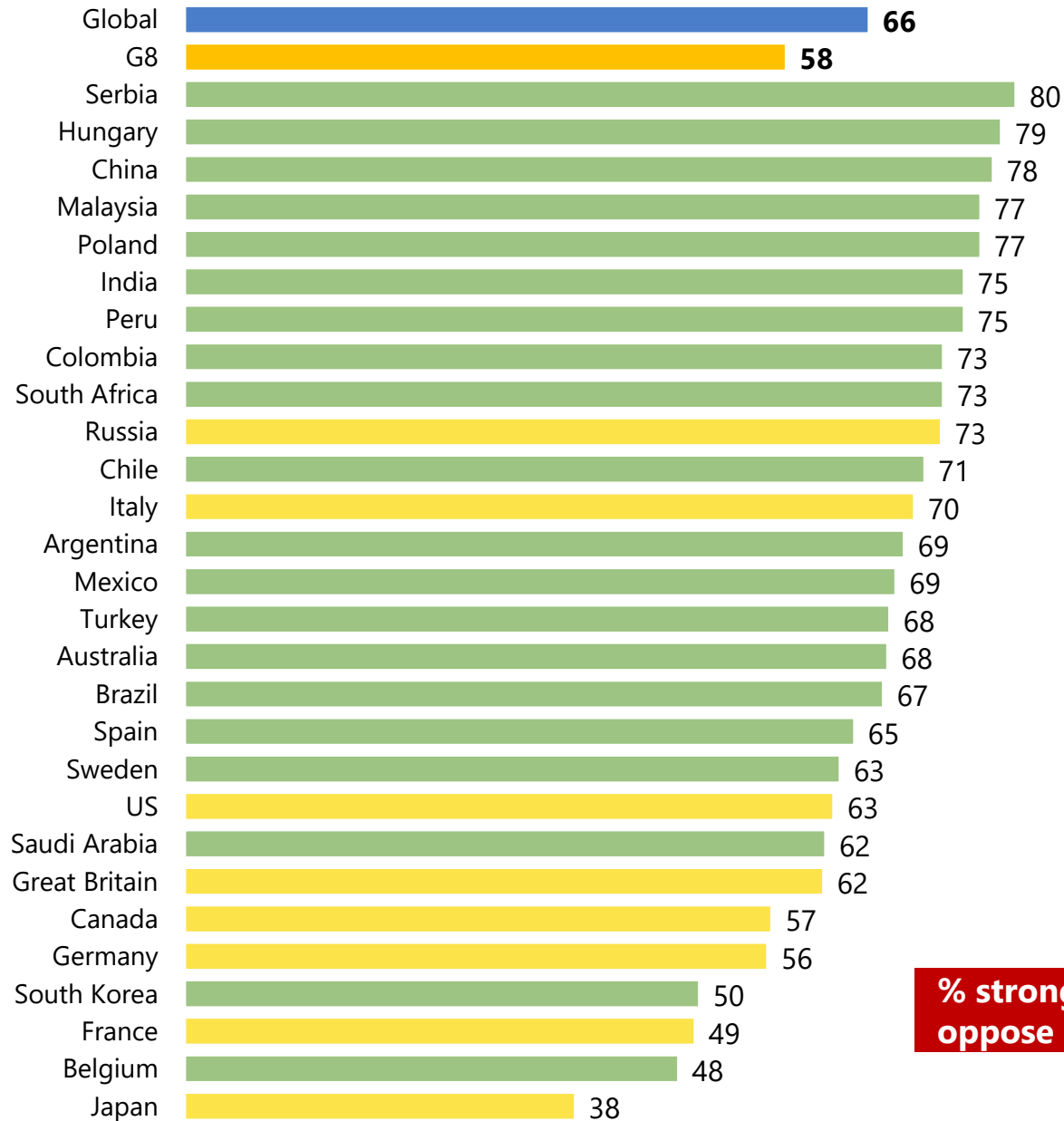

% strongly/tend to oppose

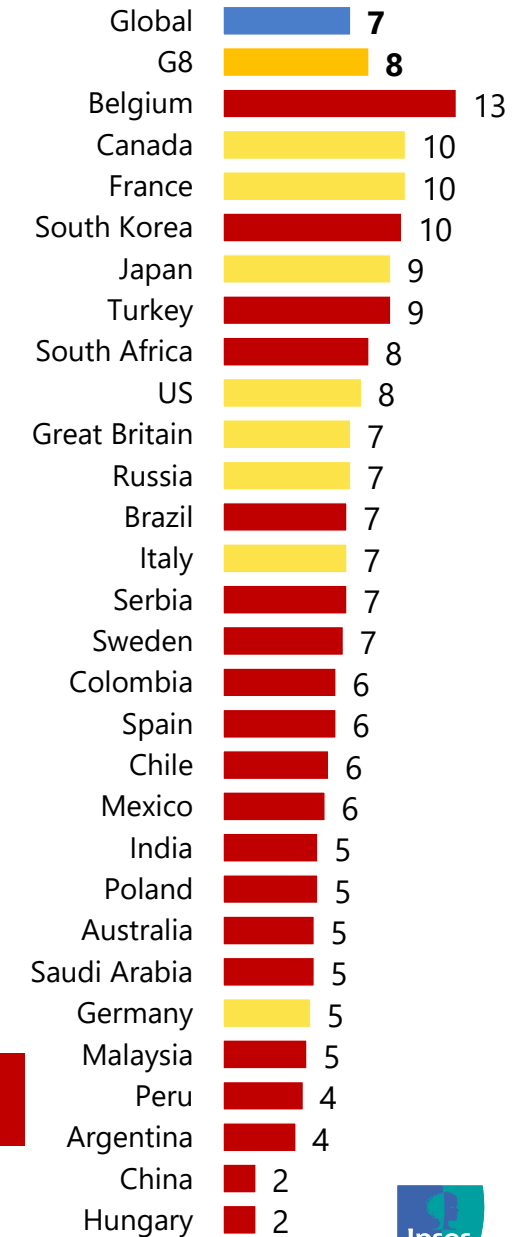

Source: Ipsos/ GIAA

Base: 19,516 adults (online), July-August 2019

Impacts

Q. Still thinking about building new infrastructure in your local area, to what extent would you support or oppose it being built there if...?

% strongly/tend to support

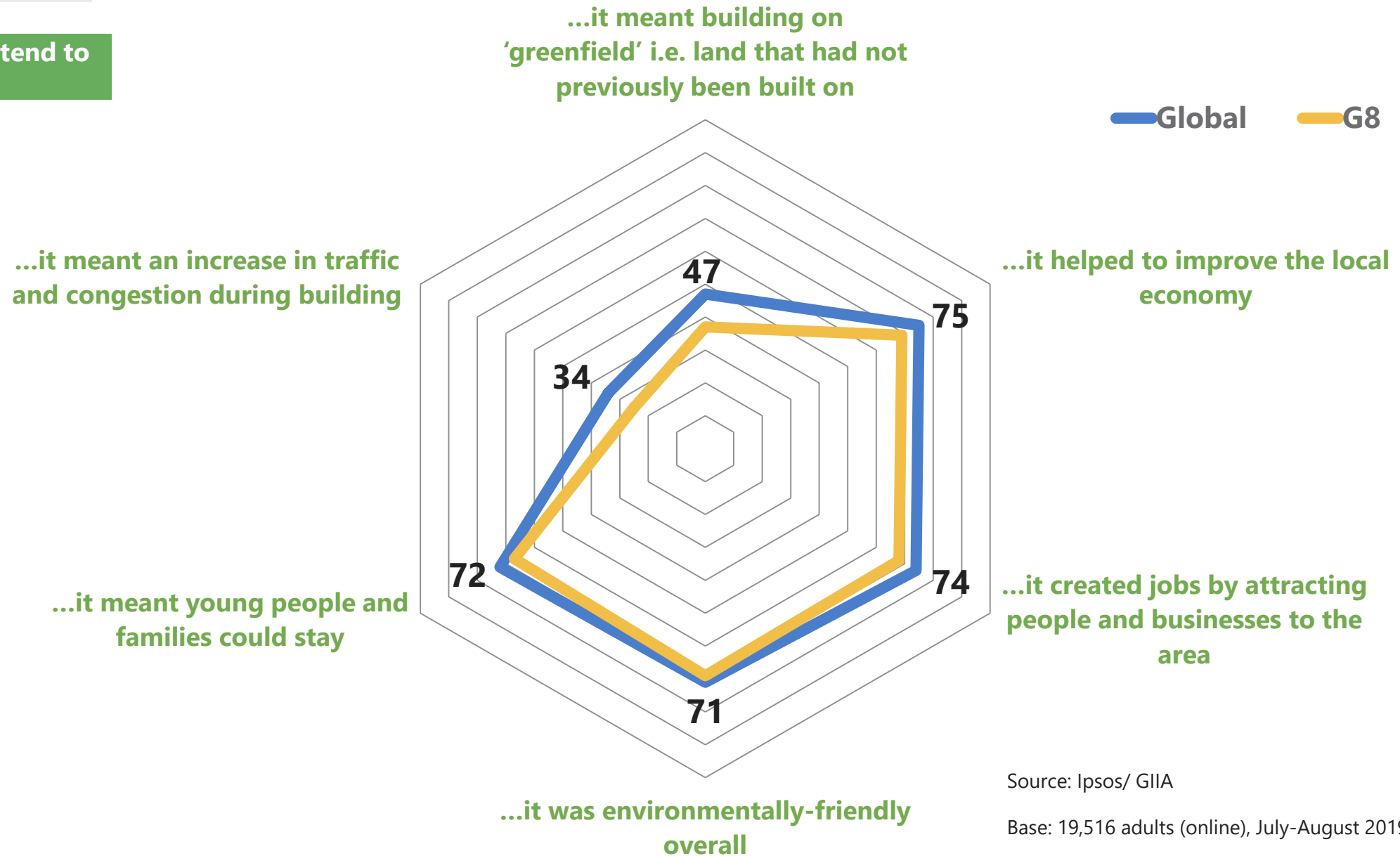

Source: Ipsos/ GIA

Base: 19,516 adults (online), July-August 2019



Types

Q. To what extent do you support or oppose, in principle, the building of the following types of infrastructure in your local area?

% strongly/tend to support

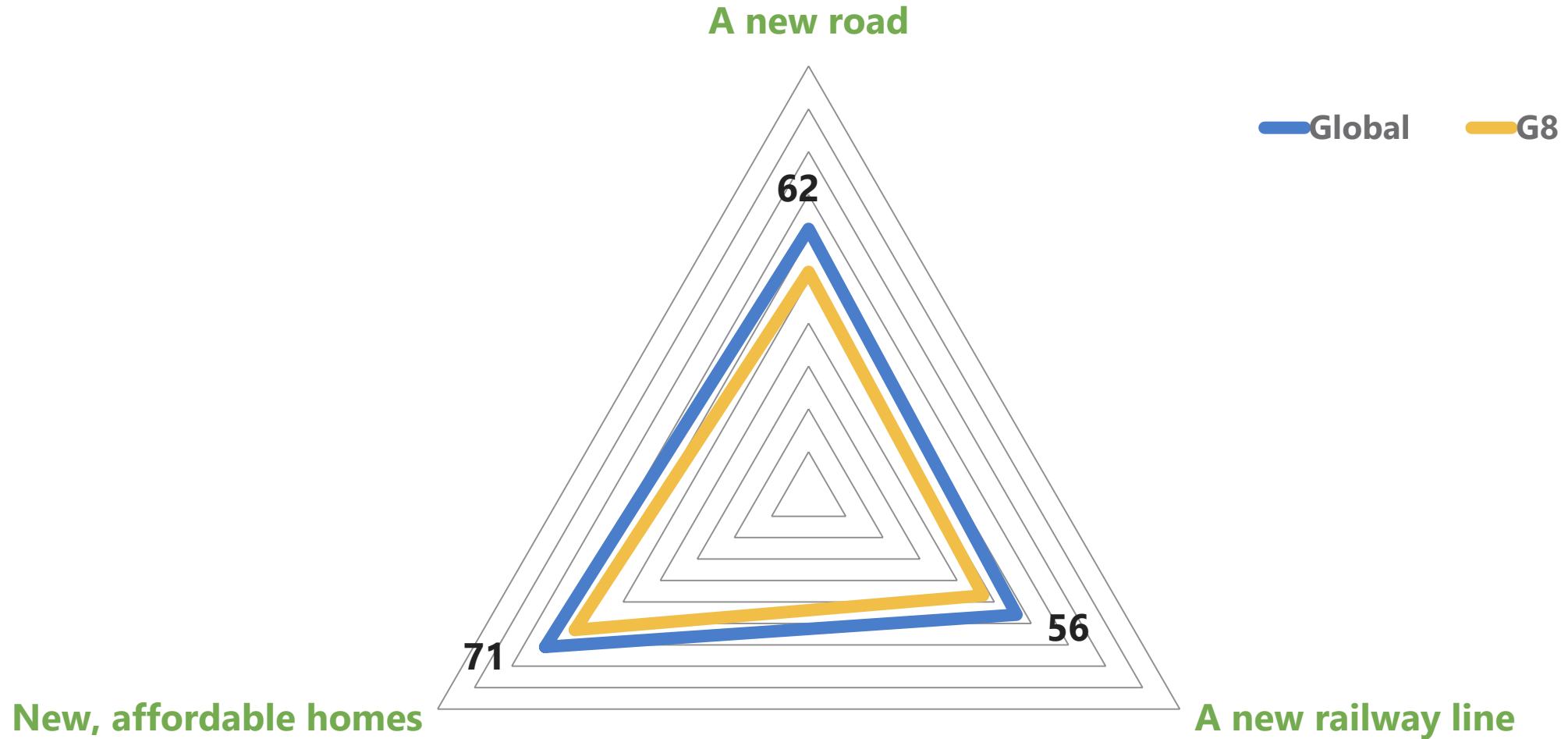

'Nimby' index

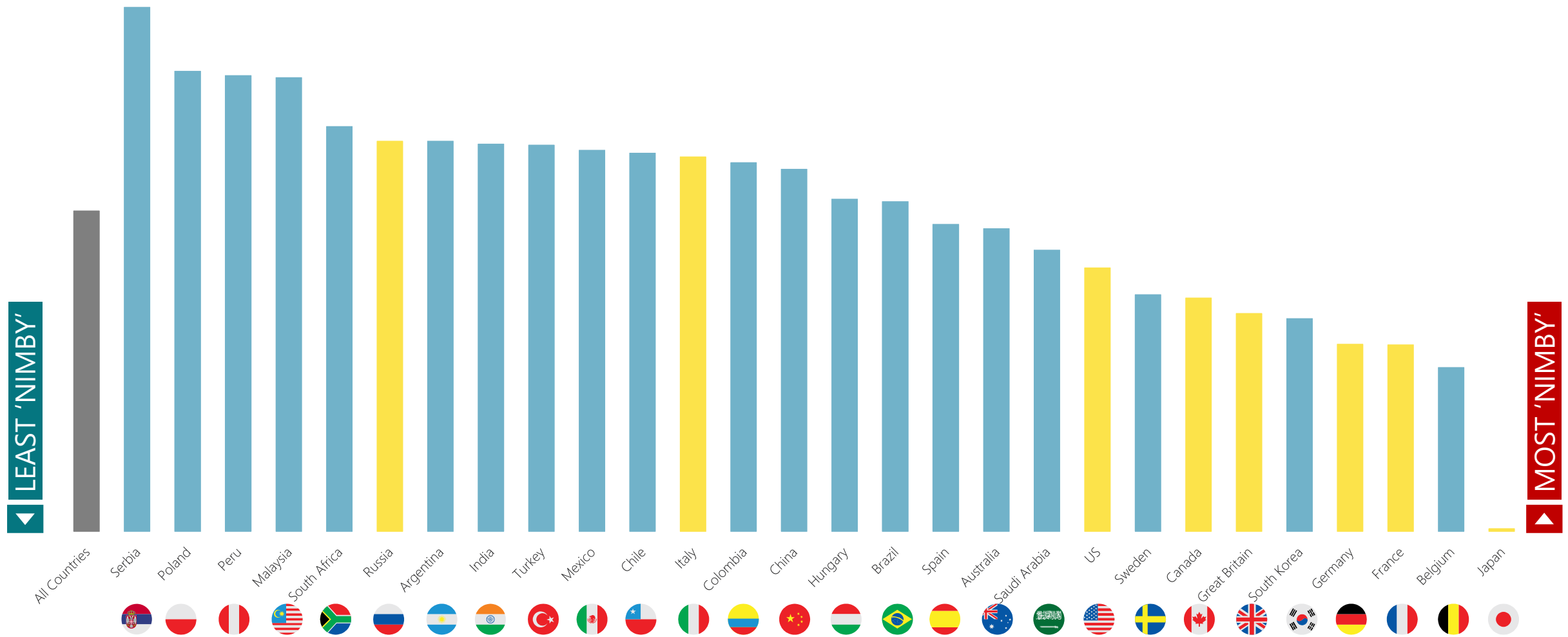

Source: Ipsos/ GIIA
 Base: 19,516 adults (online), July-August 2019



'Nimby' – segmentation

High support under positive and negative conditions (impacts)

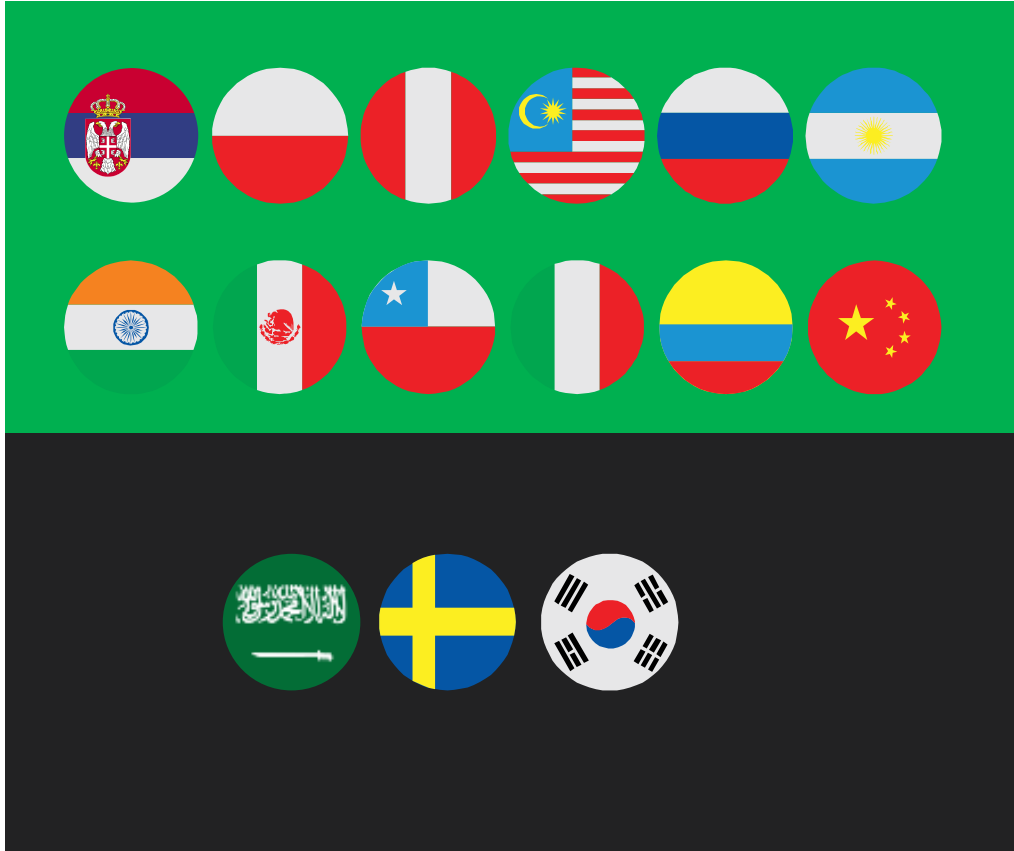

Support high/medium under positive conditions (impacts), low support under negative conditions



Medium support under positive conditions, low to medium support under negative conditions

Low support

Source: Ipsos/ GIA

Base: 19,516 adults (online), July-August 2019



Technical details

- The 'Nimby' Index has been generated as part of the fourth **Global Infrastructure Index** conducted with the support of the Global Infrastructure Investor Association.
- The survey was conducted in 28 countries around the world, via the Ipsos Online Panel system. It involved **19,516** participants, between **26 July–9 August 2019**. The countries were:

Argentina, Australia*, Belgium, Brazil, Canada*, Chile, China*, Colombia, France*, Germany*, Great Britain*, Hungary, India*, Italy*, Japan*, Malaysia, Mexico, Peru, Poland, Russia, Saudi Arabia, South Africa, South Korea, Serbia, Spain*, Sweden, Turkey and the United States of America*

** denotes 1,000+ sample size*

- Participants were adults aged 18-64 in the US and Canada, 18-65 and adults aged 16-64 in all other countries.

- The Index is based on the sum of support across Q7 which included six parts (and a mix of positive and negative 'conditions' or impacts)

Q7. Still thinking about building new infrastructure in your local area, to what extent would you support or oppose it being built there if...?

- A) ...it meant building on 'greenfield' i.e. land that had not previously been built on
- B) ...it helped to improve the local economy
- C) ...it created jobs by attracting people and businesses to the area
- D) ...it was environmentally-friendly overall
- E) ...it meant young people and families could stay
- F) ...it meant an increase in traffic and congestion during building

- These questions followed several relating to infrastructure (covering satisfaction and priorities). These presented definitions of infrastructure:

"...by infrastructure, we mean things we rely on like road, rail and air networks, utilities such as energy and water, and broadband and other communications."

- The Index runs from 1 to 100 based on participants' positivity towards building new infrastructure, with the maximum value of 100 set at Serbia which scored the highest (and Japan, at 1, the lowest). The Index thus shows the relative 'nimbyism' between countries.
- The segmentation analysis was conducted using hierarchical clustering.



Global Infrastructure Index 2019

Key findings

Key findings

Global

- After a dip last year, globally, ratings of infrastructure overall have **improved** so that now, 37% are positive (up 5 points), 30% negative (down 4) and the remainder, 33%, are neutral or don't know.
- This varies by region; e.g. there is a net *negative* margin of 4 percentage points in Europe but a *positive* one of 27 in the APAC region.
- Among sectors, and as last year, **airports** are the most positively rated (67%), followed by digital infrastructure, water supply/sewerage and motorways/major roads (54%-55%). **Flood defences** have been joined by **electric vehicle charging** as the most negatively rated sector globally (55% rate these poorly), followed by cycling infrastructure (51%).
- Several sectors are prioritised fairly equally by publics across 28 countries but **solar infrastructure** (included for the first time this year) has displaced the local road network as the top-ranked priority, closely followed by water supply/sewerage and flood defences.
- There is a strongly held conviction that infrastructure is vital to future economic growth but publics are cool on increasing taxes or borrowing to fund improvements.
- The majority would prioritise **maintaining and repairing** existing infrastructure before spending on new infrastructure, and say they would prefer decisions about new infrastructure by **technical experts** rather than politicians.
- Among eight factors, **environment** and **quality** are considered to be relatively more important in planning for the future.

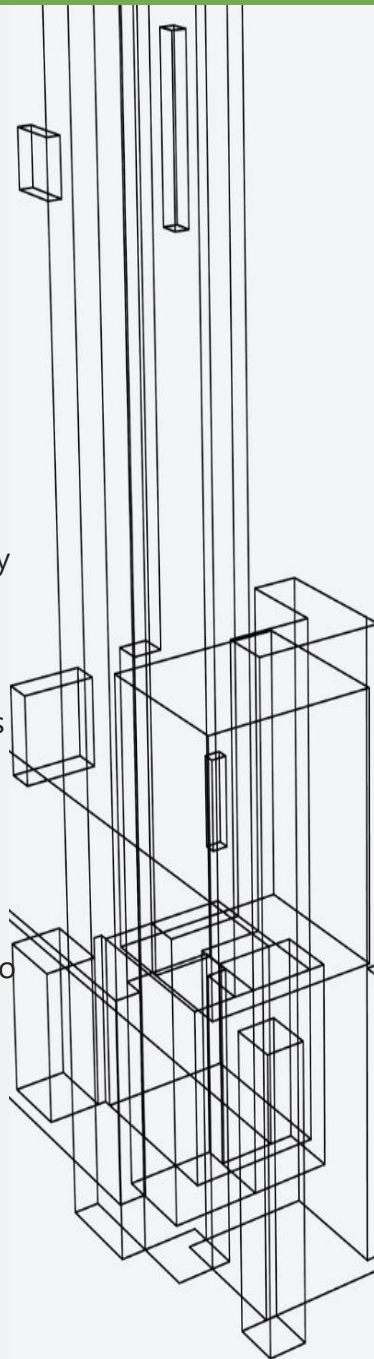

- Most are comfortable with both **foreign** and **private sector** investment in infrastructure.
- By a margin of 9:1 (66% to 7%), the public support rather than oppose, in principle, the **building of new infrastructure** in their local area. But support drops to 34% if building increases traffic and congestion, and reaches 75% if it delivers improvements to the local economy.

G8

- Compared to the global average, publics across the G8 have similar levels of satisfaction with infrastructure overall but this ranges from a high of 49% in France to just 12% in Italy.
- G8 countries are relatively more negative about several infrastructure sectors including housing supply and solar energy in particular, while also more positive about water supply and sewerage.
- The local road network is a relatively high priority for future investment compared to the global average.
- G8 citizens hold similar attitudes to those elsewhere but are *relatively* less comfortable with foreign and private investment and are more 'nimby'.



Further

information



Ipsos MORI
Social Research Institute

Ben.Marshall@ipsos.com

Hannah.Millard@ipsos.com



THoran@giia.net

JPhillips@giia.net